

BAYOU TECHE BRIDGE

(Bridge Recall No. 005800)

Carries Louisiana Highway 86 (LA 86) over Bayou Teche

New Iberia

Iberia Parish

Louisiana

HAER No. LA-29

PHOTOGRAPHS

WRITTEN HISTORICAL AND DESCRIPTIVE DATA

REDUCED COPIES OF MEASURED & INTERPRETIVE DRAWINGS

FIELD RECORDS

HISTORIC AMERICAN ENGINEERING RECORD

National Park Service

U.S. Department of the Interior

1849 C Street, NW

Washington, DC 20240

HISTORIC AMERICAN ENGINEERING RECORD
BAYOU TECHE BRIDGE
(Bridge Recall No. 005800)

HAER No. LA-29

Location: Carries Louisiana Highway 86 (LA 86) over Bayou Teche in the city of New Iberia, Iberia Parish, Louisiana.

The Bayou Teche Bridge (Bridge Recall No. 005800) is located at latitude 30.00595 north, longitude -91.81699 west.¹ The coordinate represents the southeast corner of the bridge. It was obtained in 2016 by plotting its location in Google Earth. The location has no restriction on its release to the public.

Present Owner: State of Louisiana.

Present Use: Vehicular and pedestrian traffic. When in its open position, the bridge allows for marine traffic on Bayou Teche.

Significance: This Scherzer-type, rolling-lift, bascule bridge with steel plate-girder leaves has significance as a distinctive example of the bascule type. Its significance is demonstrated by the presence of distinctive engineering and design features of the rolling-lift bascule bridge type, which is characterized by two opposing bascule leaves that roll to open. Each leaf is balanced by a rear counterweight that descends as each leaf rolls and lifts. The bridge exhibits alterations to the operator's house that result in a minor loss of integrity, but continues to convey significant design features within the bascule bridge type. This bridge was determined eligible for listing in the National Register of Historic Places (National Register) in 2013 under *Criterion C: Design/Engineering* at the state level of significance.²

Historian: Katie Ohland, Cultural Resources Specialist; Mead & Hunt, Inc. (Mead & Hunt); 2017.

Project Information: This documentation was prepared as mitigation to fulfill Stipulation IX.5 of the *Programmatic Agreement Among the Federal Highway Administration, the Louisiana Department of Transportation and Development, the Advisory Council on Historic Preservation, and the Louisiana State Historic Preservation Officer Regarding Management of Historic Bridges in Louisiana*, dated August 18, 2015, and executed September 21, 2015. The Louisiana Department of Transportation and Development (LADOTD) retained Mead & Hunt to prepare this document. It was prepared by cultural resource specialist Katie Ohland of Mead & Hunt. Dietrich Floeter completed the photography.

¹ The bridge is also known as Structure No. 03232370100141.

² Mead & Hunt, Inc., *National Register Eligibility Determination Report: Pre-1971 Louisiana Highway Bridges* (prepared for the Louisiana Department of Transportation and Development, September 2013).

Part I. Historical Information

A. Physical History:

1. **Date(s) of construction:** 1940.
2. **Engineer:** Norman E. Lant and Harry B. Henderlite, Louisiana Highway Commission.
3. **Builder/Contractor/Supplier:** Vincennes Steel Corporation of Vincennes, Indiana served as the builder/contractor for the project and also supplied much of the steel fabrication. The steel fabrication of the main bascule girders was subcontracted by Vincennes to the Virginia Bridge Company (indicated as Va. Bridge Co.).³ The James Saunders Company of Dayton, Ohio, provided the bridge's mechanical and electrical equipment.⁴
4. **Original plans and construction:** Plans available for the Bayou Teche Bridge include final tracings, as-built, shop drawings, and miscellaneous sheets. The sets of Final Tracings and As-built plan sets were prepared by the Louisiana Highway Commission (LHC). The Plan and Profile sheet is dated 1936. The as-built plan sheets with legible dates that are not standard plans are dated 1939, with several sheets showing changes dated 1941. Shop drawings include plan sets by the James Saunders Company and the Vincennes Steel Corp., with notes on at least three sheets pertaining to the Virginia Bridge Co., all generally dated 1940 and 1941.

Copies of the original plan sheets are available in the General Files room at the LADOTD's Baton Rouge headquarters. Construction of the bridge began in 1939; it was completed in 1940 and opened to traffic in 1941.
5. **Alterations and additions:** Alterations to the bridge include the replacement of the bridge deck flooring over the main span in 1955. Additionally, modifications have been made to the operator's house, although the date of these changes is not known.

³ See shop drawing sheets 2, 3, and 4 of 19, Contract 6265, Vincennes Steel Corp. for Bascule over Bayou Teche on Bridge St. in New Iberia, for Louisiana Highway Commission, available in the General Files room, Louisiana Department of Transportation and Development, Baton Rouge, La. Though barely legible, each sheet is dated "4-22-40"; the note on sheet 2 (bascule girder) states "All Material on This Sheet Furnished by Va. Bridge Co.," with similar note on sheets 3 and 4.

⁴ See plan set of nine sheets of machinery shop drawings and additional sheets for electrical equipment and wiring for Bayou Teche Bridge prepared by The James Saunders Company, Dayton, Ohio, Manufacturers-Contractors, for The Vincennes Steel Corp, approved January 30, 1940, available in the General Files room, Louisiana Department of Transportation and Development, Baton Rouge, La.

B. Historical Context:

Historical background

Depression-era federal relief programs kept the highway building boom of the 1920s alive through the 1930s. Federal projects dwindled after 1938, however, as New Deal programs wound down. The infrastructure construction boom of this era also came to an end as the U.S. became involved in World War II.⁵ During the period, bridge designs and construction projects in Louisiana were completed by the LHC's Bridge Department. The Bayou Teche Bridge was constructed at the tail end of federal work relief efforts but did not receive funds through those programs. Instead, the bridge was funded by the State of Louisiana's General Fund for bridge and highway construction.⁶

Design and construction of the Bayou Teche Bridge

Necessitated by a population increase in New Iberia during the 1930s, the Bayou Teche Bridge was built in 1939-1940. Two earlier structures had existed on the site: a pontoon first used in 1851 and a steel and wood bridge built by the City of New Iberia in 1896. The crossing served not only the downtown, but also the heavily populated surrounding rural areas of the Loreauville and the West Atchafalaya basin. Upon completion, the new span was the only double-leaf, Scherzer-type, rolling-lift, bascule bridge in the state of Louisiana. The generous 15'-0" vertical clearance allowed more vessels to pass below, reducing the number of bascule openings. Combined with the fast opening and closing times of the electrically powered bridge, the overall effect was to substantially reduce the impact on traffic flow of both vehicles and vessels, making it "a superior type of bridge for use on this busy thoroughfare," according to a news report of the opening.⁷

While construction of the bridge began in November 1939, planning for the structure commenced several years earlier.⁸ In 1936 the U.S. War Department approved the clearance of the bridge above the Bayou Teche.⁹ Norman E. Lant and Harry B. Henderlite, prominent and influential LHC engineers, designed the bridge.¹⁰ The shop drawings indicate that the James Saunders Company of Dayton, Ohio, supplied the bridge's mechanical and electrical equipment and the Virginia (Va.) Bridge Company fabricated the key

⁵ Louisiana Highway Commission, *Biennial Report of the Louisiana Highway Commission of the State of Louisiana* (Baton Rouge, La.: Louisiana Highway Commission, 1938-1939), 13-18; Mead & Hunt, Inc., *Historic Context for Louisiana Bridges* (prepared for the Louisiana Department of Transportation and Development, 2013), 27.

⁶ Louisiana Highway Commission, *Biennial Report of the Louisiana Highway Commission of the State of Louisiana*, 28-29.

⁷ "New Iberia Span, Costing \$152,000, to Open Sunday," *The Times-Picayune*, January 18, 1941. The bascule span was engineered for an opening time of 1.5 minutes; see note below "Partial List of Mechanical and Electrical Equipment" in plan sheet titled "74' Rolling Lift Bascule Span, 30'-0" Roadway-2-5'-0" Sidewalks," Louisiana Highway Commission, July 1939, in both the as-built and final tracings plan sets, available in the General Files room, Louisiana Department of Transportation and Development, Baton Rouge, La.

⁸ "New Iberia Span, Costing \$152,000, to Open Sunday."

⁹ "Clearances Approved," *The Times-Picayune*, January 11, 1936.

¹⁰ "New Iberia Span, Costing \$152,000, To Open Sunday," 14.

steel bascule girders. The Vincennes Steel Corporation provided the remainder of the steel fabrication. The operator's house is the only major component of the bridge that, according to the plans, followed an LHC standard plan.¹¹

Born in Evansville, Indiana, in 1889, Lant was educated at Purdue University, graduating ca. 1913 with a civil engineering degree.¹² He worked as the head of bridge engineering within the LHC (later the Louisiana Department of Highways [LDH]) from 1922 to 1955. As Bridge Engineer, he oversaw the design and construction, whether in-house or through consultants, of every major bridge in the state for 33 years. He was perhaps the single most important engineer and bridge designer in the Bridge Department in the first half of the twentieth century.¹³

Henderlite was born in Raleigh, North Carolina, in 1893. In the 1920s he worked as a civil engineer in North Carolina's highway department and as State Highway Commissioner.¹⁴ In 1929 he was one of five engineers in North Carolina recruited to Louisiana by Governor Huey Long.¹⁵ Henderlite served as State Highway Engineer for six years, from 1929 to 1930 and 1934 to 1939, and as Chief Engineer in the early 1940s until 1946, when he retired. He is important to the early development of Louisiana's roads and bridges and is credited with bringing success to the LHC.¹⁶

On September 15, 1939, the LHC awarded the bridge construction contract to the Vincennes Steel Corporation of Vincennes, Indiana, for a cost of approximately \$152,000, and construction began two months later.¹⁷ The company was founded in southwest Indiana in 1899 and was responsible for constructing many truss and movable bridges in southeastern states, including Louisiana. It reincorporated as the Vincennes Steel Corporation in 1932 to reflect the additions of steel manufacturing and contracting to its traditional business of bridge building.¹⁸ The bridge was completed in October 1940, and opened for traffic following a ceremony in January 1941.¹⁹

¹¹ Louisiana Highway Commission, "Bayou Teche Bridge," 1939, as-built plans, available in the General Files room, Louisiana Department of Transportation, Baton Rouge, La.

¹² *Encyclopedia of American Biography* (West Palm Beach, Fla.: American Historical Company, Inc., 1969), 44; "Norman Lant Previously Designed and Supervised Building of Highway Bridges," *Evansville Press* (Indiana), 1946, <http://local.evpl.org/views/viewimage.asp?ID=904045> (accessed August 17, 2016).

¹³ Mead & Hunt, Inc., *Historic Context for Louisiana Bridges*, 97-99.

¹⁴ *1920 United States Federal Census record for Harry Henderlite; Biennial Report of the Attorney-General of the State of North Carolina, 1922-1924* (Raleigh, N.C.: Edwards and Beoughton Printing Co., 1924), 217.

¹⁵ "Louisiana Highway Engineers Resign," *Biloxi Daily Herald* (Mississippi), April 18, 1933.

¹⁶ Mead & Hunt, Inc., *Historic Context for Louisiana Bridges*, 97-100.

¹⁷ "4 Highway Project Contracts Given," *The Times-Picayune*, September 15, 1939.

¹⁸ National Register of Historic Places, Multiple Property Documentation Form, "Historic Bridges of Arkansas," Statewide, Arkansas, NR# 64500021, E11-E12.

¹⁹ "New Iberia Span, Costing \$152,000, to Open Sunday."

In 1955 the Louisiana Department of Highways (LDH, successor to the LHC) removed the asphalt and timber plank deck flooring on the main span and adjacent sidewalks and replaced it with a new open grid steel deck, with a steel plating over the sidewalks.²⁰ At an unknown date, window sash were removed from the lower level of the operator's house, leaving empty window openings (upper level windows are intact).

Bascule bridges

Louisiana has one of the largest collections of movable bridges of any state, thanks to its proliferation of navigable waterways, particularly in the southern section of the state near the Gulf of Mexico. In addition to the large number, Louisiana also has a wide variety of types and sizes of movable bridges. Movable bridges are comprised of three major types found in Louisiana and throughout the country: swing-span, bascule, and vertical lift.²¹

The bascule type is found nationwide, with the earliest examples constructed before 1930. Standard plans for bascule bridges in Louisiana were issued from 1929 to 1949, and bascule bridges make up nine percent of the pre-1971 movable bridges in Louisiana. The type is considered uncommon in the state compared to other movable bridge types.²²

A bascule bridge can be described as a seesaw, where the span pivots vertically around a balance point near the center. As one end is raised, the other end descends. This movement, in fact, is represented in the term "bascule," which is derived from the French word "bacule" or seesaw. When viewed in a bridge design, this analogy describes the most common and most simple of the bascule types, the trunnion bascule. In this design, as in other bascule bridge designs, the raised end of the span is termed the bascule "leaf," the descending end is the counterweight, and the trunnion is a shaft on which the span pivots. In addition to the trunnion type are two other general bascule designs: the rolling-lift bascule and the heel trunnion.

The simplest bascule bridges are single-leaf, with the leaf extending over the waterway and resting on an abutment opposite the pivot point when in the closed position. If a wider navigation channel is required, two movable leaves may be placed opposite each other for a double-leaf bascule. The double-leaf configuration functions for vehicular traffic but is not stable enough for the greater loads of railroads.²³

The Bayou Teche Bridge is an example of a rolling-lift bascule bridge in a double-leaf configuration. This rolling-lift bridge is also known as a Scherzer-type, rolling-lift bascule for the holders of the original 1893 patent by brothers William and Albert Scherzer. Unlike the trunnion design, in which the span pivots on the trunnion, the rolling lift design allows the entire span to rock back on curved sections of the bridge

²⁰ State of Louisiana, Department of Highways, "Repairs to Bayou Teche Bridge," 1955, Construction plans, available in the General Files room, Louisiana Department of Transportation, Baton Rouge, La.

²¹ Mead & Hunt, Inc., *Historic Context for Louisiana Bridges*, 72, 73.

²² Mead & Hunt, Inc., *Historic Context for Louisiana Bridges*, 73, 81.

²³ Mead & Hunt, Inc., *Historic Context for Louisiana Bridges*, 78.

girders themselves, which ride on tracks mounted atop the abutment or within the pier. In this configuration, as the bascule girder rolls horizontally back in a rocking motion the leaf rises vertically away from the navigation channel, and the attached counterweight drops down in a pit. In the rolling-lift design the bridge loads are transferred for the bascule girder directly to the pier or abutment without going through a trunnion. The rolling-lift design was popular because of its simplicity, its opening speed, and its limited power requirements for operation. However, the rolling-lift action also was a drawback because the point of load transfer from the moving girder to the track on the pier top was constantly changing as the span was in motion. The rolling action caused piers to shift position if they were not securely founded on bedrock, a problem that engineers eventually solved in later examples. Rolling-lift bridges can be single- or double-leaf.²⁴

Nationally, Scherzer rolling-lift bridges were built into the 1940s. Among bascule types, the Scherzer proved popular for railroads, but was less common for vehicular use. The trunnion bascule became the more popular design for vehicles, particularly for crowded urban locations where the more compact trunnion structure was a better fit.²⁵

Part II. Structural/Design Information

A. General Statement:

1. Character: The Bayou Teche Bridge is a Scherzer-type, rolling-lift, bascule bridge. It is the state's only example of this bascule bridge type.

2. Condition of fabric: Good.

B. Description: The Bayou Teche Bridge is a seven-span, Scherzer-type, rolling-lift, bascule bridge. Centrally located within the city of New Iberia, the bridge carries LA 86, locally known as Duperior Street, over the Bayou Teche. The bridge is aligned on a northeast-southwest axis, and the Bayou Teche is aligned from northwest to southeast at the bridge location. The bridge superstructure consists of a double-leaf, rolling-lift, bascule main span; two pier spans; and four simple steel-beam approach spans. According to the original plans, the total structure length is 241'-0" and the main span is 74'-0". Each leaf of the main span is 37'-0" long from the center line of the roll or pinion to the front end of the leaf at the center of the main span. Each leaf extends an additional 11'-0" from the centerline of the roll to the opposite end of the girder at the counterweight, making each bascule girder 48'-0" in total length. The two westernmost approach spans (spans 1 and 2) are each 35'-0" feet in length and the two easternmost approach spans (spans 6 and 7) are each 30'-0" in length. The pier spans (spans 3 and 5) are each

²⁴ Parsons Brinkerhoff and Engineering and Industrial Heritage, *A Context for Common Historic Bridge Types, NCRHP Project 25-25, Task 15* (prepared for the National Cooperative Highway Research Program, the Transportation Research Council and the National Research Council, October 2005), 3-129.

²⁵ Mead & Hunt, Inc., *Historic Context for Louisiana Bridges*, 79, 80; Parsons Brinkerhoff and Engineering and Industrial Heritage, *A Context for Common Historic Bridge Types*, 3-129.

18'-6" in length. The out-out bridge width is approximately 40'. The bridge has a 30'-0" wide roadway between curbs with 5'-0" wide sidewalks that are cantilevered on brackets on both sides. A two-story concrete operator's house is located adjacent to the north side of the east pier.

Main span

Each leaf of the main span is constructed with two riveted, plate, bascule girders that support a floor system and a counterweight. Each girder is designed with a curve at the pinion that moves on a cast-metal track. Each leaf has a leaf-mounted electric motor with gear reducers that drive pinions in each leaf end, at the center line of the roll. The pinion gear pulls the leaf horizontally along a cast rack frame. As the pinions move, the curved segments at the center line of the bascule girder roll back on the flat track mounted on the pier. This movement rocks the leaf so the concrete counterweight descends into the pier pit and the opposite end of the girders lifts up. As this movement occurs, the center line of the roll moves horizontally 7'-7.5" for a 70-degree angle maximum opening of the leaf. As both leaves complete this motion simultaneously, the bridge is opened for navigation traffic. At the bridge main span, the Bayou Teche is lined with a timber fender on both sides creating an approximately 60' wide horizontal clearance for navigable traffic.

The floor system of each leaf is comprised of four built-up or rolled I-section floorbeams of varying sizes and six lines of rolled I-section stringers. A steel grid deck is mounted on the stringers. Portions of the grid are filled with concrete, specifically over the piers and at the leaf ends. A metal plunger system locks the leaf ends together when the leaves are in the closed position. Bottom diagonal bracing comprised of angles is located between the floorbeams. A strut extends between the bascule girders directly below the pinions. Steel-plate sidewalks are cantilevered on metal brackets on both sides of the main span. The main-span railings consists of metal posts and a simple metal balustrade with one rail on top and a pair of rails at the bottom. The bascule leaf railings are slightly inset from the approach span railings to accommodate the main span movement.

Approach spans

The approach spans are simple beam spans, each with seven I-section stringers and a concrete deck. Concrete diaphragms are located between the stringers. Concrete railings, with oval openings that are cast in panels with a heavier concrete cap and concrete posts, line the sidewalks that are cantilevered on concrete brackets on both sides of the approach spans. A metal crossing guard is mounted on a rectangular concrete base that is supported by curved concrete brackets attached to the back of each wingwall. Curved metal light standards on tall, square, concrete bases are mounted on concrete endposts at the four corners of the bridge. Stepped concrete pilasters are located above each wingwall at the four corners of the bridge. On the southwest and northeast pilasters, "Bayou Teche" is formed into the concrete surface and "1940" is formed onto the northwest and southeast pilasters.

Bridge piers

The piers are comprised of four walls that create an enclosed space around the operating machinery and counterweight pit. The deck is supported over each pier (spans 3 and 5) by a cantilevered extension of stringers from the adjacent approach span (spans 2 or 6) and a cantilevered extension of the bascule leaf, which meet at an angled joint. The continuous stringers of approach spans 2 and 6 extend 7'-6" over

each pier span. The remaining 11'-0" of the deck is supported by the bascule leaf, reaching the total pier span length of 18'-6". This portion of the bascule stringer is measured from the center line of the roll to the back end of the leaf. Three access hatches provide entry to the pier interiors. Two hatches are located on the sidewalks above the western pier, one on each side of the bridge. The third is located on the southern sidewalk above the eastern pier. A door across from the lower level of the operator's house also provides interior access to the eastern pier.

Substructure

The bridge substructure consists of reinforced-concrete abutments, two piers, and two bents. The abutments are U-shaped with straight wingwalls perpendicular to the roadway. Each bent consists of six piles with a rectangular bent cap. Each large, rectangular pier encloses a counterweight pit, the roll track for the bascule girders, and pinion support. The piers are enlarged with tall bays on cantilevered concrete brackets just above the waterline. The sidewalks and railings follow the pier bay extension. The north and south pier walls on both piers each have a single square access opening with concrete sills and lintels. Each pier backwall has a pair of large, rectangular openings for machinery access.

Operator's house

The standalone, two-story, concrete operator's house is based on an LHC standard plan. Rectangular in plan, it rests on four square concrete piles and has a flat roof. It is connected to the north side of the eastern pier 2 by rolled I-beams at the pier foundation and by an extension of the concrete sidewalk at the deck. In plan, the operator's house is 15'-3" long by 10'-6" wide. The lower level of the south facade has a double door opening; the upper level has a central entrance bay flanked by window bays. Both lower and upper levels of the north facade have two window bays. The upper and lower levels of the east and west facades have a single window bay. All windows in the upper level are metal, six-over-six, double-hung sash. The lower level openings have no sash. According to the plans, they were originally the same as those on the upper level. All bays are defined by full-height concrete pilasters. The upper level interior of the operator's house includes a control room with a control console. The lower level interior is empty.

C. Site Information: The Bayou Teche Bridge spans the Bayou Teche in New Iberia, Iberia Parish, Louisiana. South of New Iberia the Bayou Teche winds southeast approximately 50 miles, passing through several other towns before flowing into the Gulf of Mexico. Centrally located within New Iberia, the bridge connects to an urban grid with commercial buildings on the west side of the bridge and a residential neighborhood on the east side. Around the bridge, the Bayou Teche is lined with grass, vegetation, deciduous trees, and businesses. The bridge carries two lanes of vehicular traffic, one in each direction.

Part III. Sources of Information

A. Primary Sources:

"4 Highway Project Contracts Given." *The Times-Picayune*, September 15, 1939.

Biennial Report of the Attorney-General of the State of North Carolina, 1922-1924. Raleigh, N.C.: Edwards and Beoughton Printing Co., 1924.

"Clearances Approved." *The Times-Picayune*, January 11, 1936.

Louisiana Highway Commission. "Bayou Teche Bridge." 1939. As-built plans. Available in the General Files room, Louisiana Department of Transportation and Development, Baton Rouge, La.

Louisiana Highway Commission. *Biennial Report of the Louisiana Highway Commission of the State of Louisiana*. Baton Rouge, La.: Louisiana Highway Commission, 1938-1939.

"Louisiana Highway Engineers Resign." *Biloxi Daily Herald* (Mississippi), April 18, 1933.

"New Iberia Span, Costing \$152,000, To Open Sunday." *The Times-Picayune*, January 18, 1941.

"Norman Lant Previously Designed and Supervised Building of Highway Bridges." *Evansville Press* (Indiana), 1946. <http://local.evpl.org/views/viewimage.asp?ID=904045> (accessed August 17, 2016).

Parsons Brinkerhoff and Engineering and Industrial Heritage. *A Context for Common Historic Bridge Types, NCRHP Project 25-25, Task 15*. Prepared for the National Cooperative Highway Research Program, the Transportation Research Council and the National Research Council, October 2005.

State of Louisiana, Department of Highways. "Repairs to Bayou Teche Bridge." 1955. Construction plans. Available in the General Files room, Louisiana Department of Transportation and Development, Baton Rouge, La.

B. Secondary Sources:

Encyclopedia of American Biography. West Palm Beach, Fla.: American Historical Company, Inc., 1969.

Mead & Hunt, Inc. *Crossing the Bayou: Louisiana's Historic Bridges*. Prepared for the Louisiana Department of Transportation and Development, 2015.

Mead & Hunt, Inc. *Historic Context for Louisiana Bridges*. Prepared for the Louisiana Department of Transportation and Development, December 2013.

Mead & Hunt, Inc. *National Register Eligibility Determination Report: Pre-1971 Louisiana Highway Bridges*. Prepared for the Louisiana Department of Transportation and Development, September 2013.

National Register of Historic Places, Multiple Property Documentation Form. "Historic Bridges of Arkansas." Statewide, Arkansas.

Seely, Bruce. *Building the American Highway System: Engineers as Policy Makers*. Philadelphia: Temple University Press, 1987.

HISTORIC AMERICAN ENGINEERING RECORD

INDEX TO PHOTOGRAPHS

BAYOU TECHE BRIDGE

HAER No. LA-29

(Bridge Recall No. 005800)

Carries Louisiana Highway 86 (LA 86) over Bayou Teche

New Iberia

Iberia Parish

Louisiana

INDEX TO BLACK AND WHITE PHOTOGRAPHS

Dietrich G. Floeter, photographer, February and March 2016

Scale Device 8 Feet Long

- | | |
|----------|--|
| LA-29-1 | Southeast elevation, from south |
| LA-29-2 | Northwest elevation, from north |
| LA-29-3 | Northeast approach, from northeast |
| LA-29-4 | Southwest approach, from southwest |
| LA-29-5 | Southeast elevation on centerline with 8-foot scale device, from southeast |
| LA-29-6 | Southeast elevation on centerline, from southeast |
| LA-29-7 | General view of bridge, from north |
| LA-29-8 | Area view of bridge, from north |
| LA-29-9 | Area view of bridge, from southeast |
| LA-29-10 | Detail view of open bridge showing underside of bascule leaf, from southwest |
| LA-29-11 | Detail view of open bridge, from south |
| LA-29-12 | Wider view of open bridge, from south |
| LA-29-13 | View from bridge to southeast, from northwest |
| LA-29-14 | View from bridge to northwest, from southeast |

BAYOU TECHE BRIDGE
HAER No. LA-29
INDEX TO PHOTOGRAPHS

- LA-29-15 Detail view of east abutment, from south
- LA-29-16 Detail view of west abutment, from east
- LA-29-17 Detail view of operator's house interior, from northeast
- LA-29-18 Detail view of concrete railing, from southwest
- LA-29-19 Detail view of bascule leaf on metal track, pinion with metal rack, and counterweight pit, from southeast
- LA-29-20 Detail view of counterweight, from southeast
- LA-29-21 Detail view of underside and pier with openings to counterweight pit, from northeast
- LA-29-22 Detail of bridge deck, from southwest

BAYOU TECHE BRIDGE
HAER No. LA-29
INDEX TO PHOTOGRAPHS

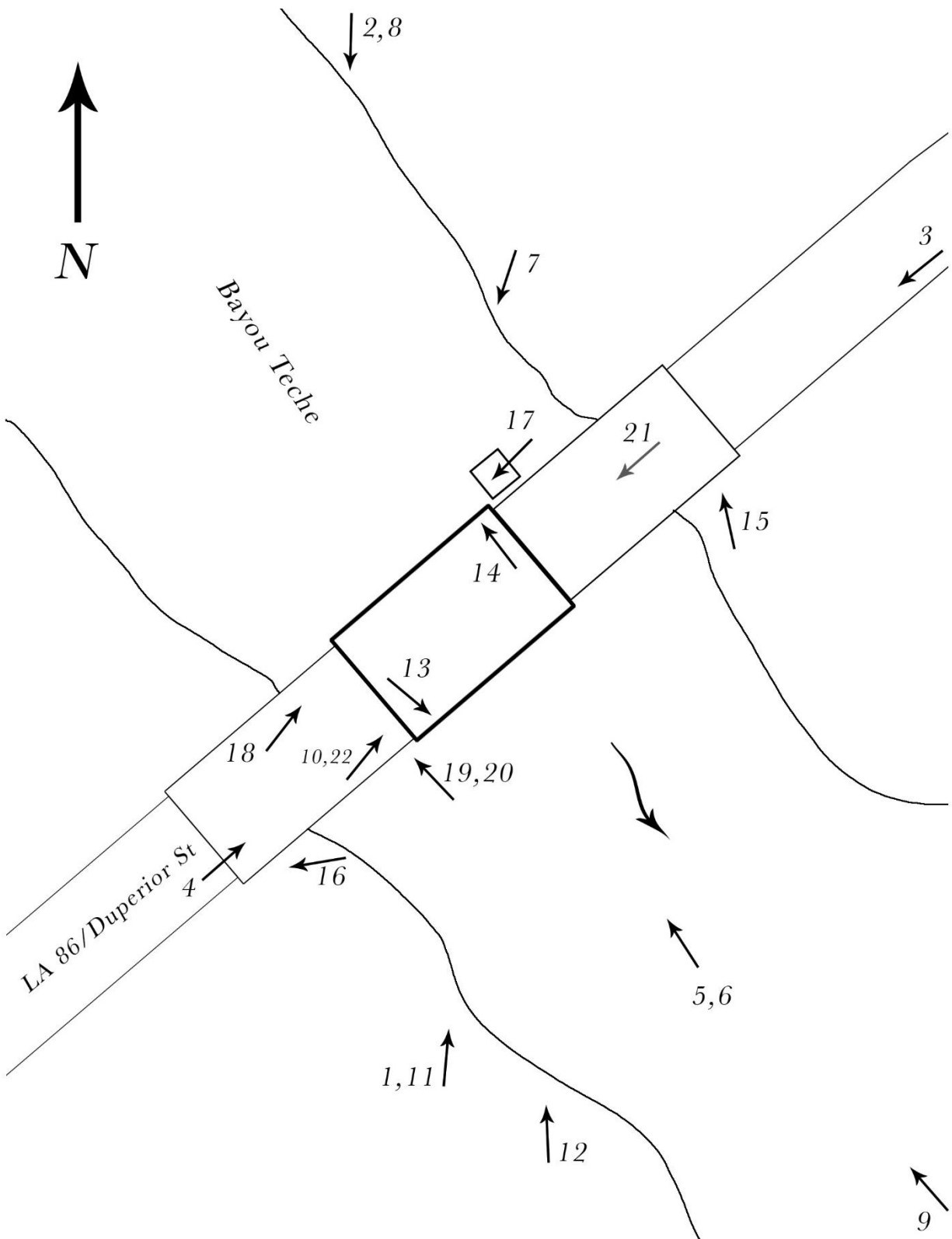

HISTORIC AMERICAN ENGINEERING RECORD
See Index to Photographs for Caption
HAER NO. LA-29-1



HISTORIC AMERICAN ENGINEERING RECORD
See Index to Photographs for Caption
HAER NO. LA-29-2



HISTORIC AMERICAN ENGINEERING RECORD
See Index to Photographs for Caption
HAER NO. LA-29-3



HISTORIC AMERICAN ENGINEERING RECORD

See Index to Photographs for Caption

HAER NO. LA-29-4



HISTORIC AMERICAN ENGINEERING RECORD
See Index to Photographs for Caption
HAER NO. LA-29-5



HISTORIC AMERICAN ENGINEERING RECORD
See Index to Photographs for Caption
HAER NO. LA-29-6



HISTORIC AMERICAN ENGINEERING RECORD
See Index to Photographs for Caption
HAER NO. LA-29-7



HISTORIC AMERICAN ENGINEERING RECORD
See Index to Photographs for Caption
HAER NO. LA-29-8



HISTORIC AMERICAN ENGINEERING RECORD
See Index to Photographs for Caption
HAER NO. LA-29-9



HISTORIC AMERICAN ENGINEERING RECORD
See Index to Photographs for Caption
HAER NO. LA-29-10



HISTORIC AMERICAN ENGINEERING RECORD
See Index to Photographs for Caption
HAER NO. LA-29-11



HISTORIC AMERICAN ENGINEERING RECORD
See Index to Photographs for Caption
HAER NO. LA-29-12



HISTORIC AMERICAN ENGINEERING RECORD
See Index to Photographs for Caption
HAER NO. LA-29-13



HISTORIC AMERICAN ENGINEERING RECORD
See Index to Photographs for Caption
HAER NO. LA-29-14



HISTORIC AMERICAN ENGINEERING RECORD
See Index to Photographs for Caption
HAER NO. LA-29-15



HISTORIC AMERICAN ENGINEERING RECORD
See Index to Photographs for Caption
HAER NO. LA-29-16



HISTORIC AMERICAN ENGINEERING RECORD
See Index to Photographs for Caption
HAER NO. LA-29-17



HISTORIC AMERICAN ENGINEERING RECORD
See Index to Photographs for Caption
HAER NO. LA-29-18



HISTORIC AMERICAN ENGINEERING RECORD
See Index to Photographs for Caption
HAER NO. LA-29-19

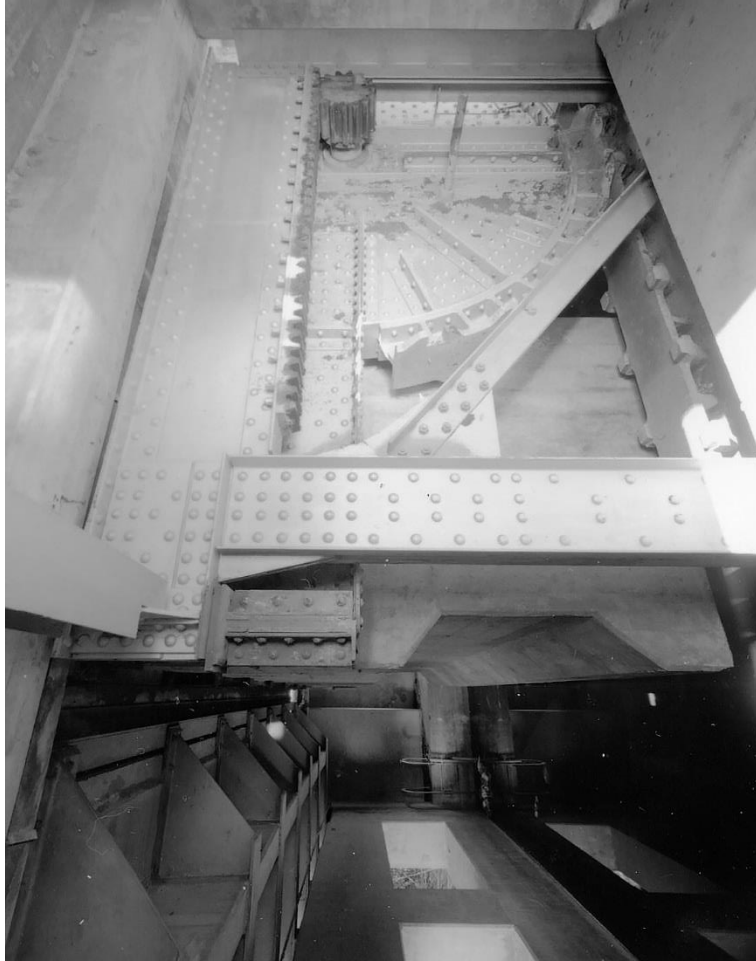

HISTORIC AMERICAN ENGINEERING RECORD
See Index to Photographs for Caption
HAER NO. LA-29-20

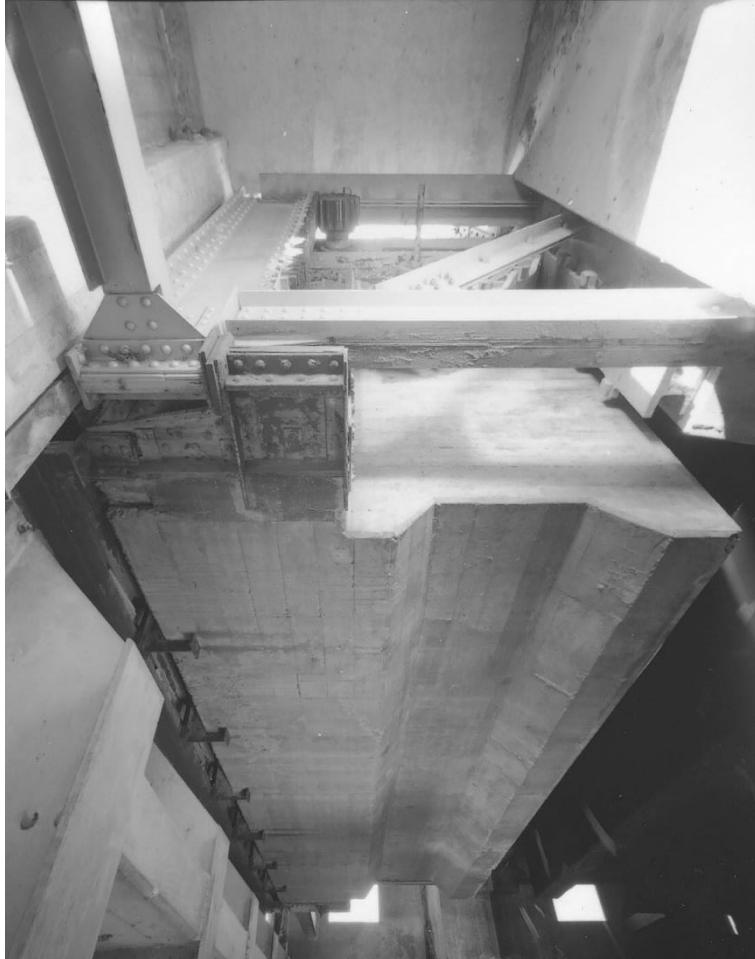

HISTORIC AMERICAN ENGINEERING RECORD
See Index to Photographs for Caption
HAER NO. LA-29-21



HISTORIC AMERICAN ENGINEERING RECORD
See Index to Photographs for Caption
HAER NO. LA-29-22



BAYOU TECHE BRIDGE

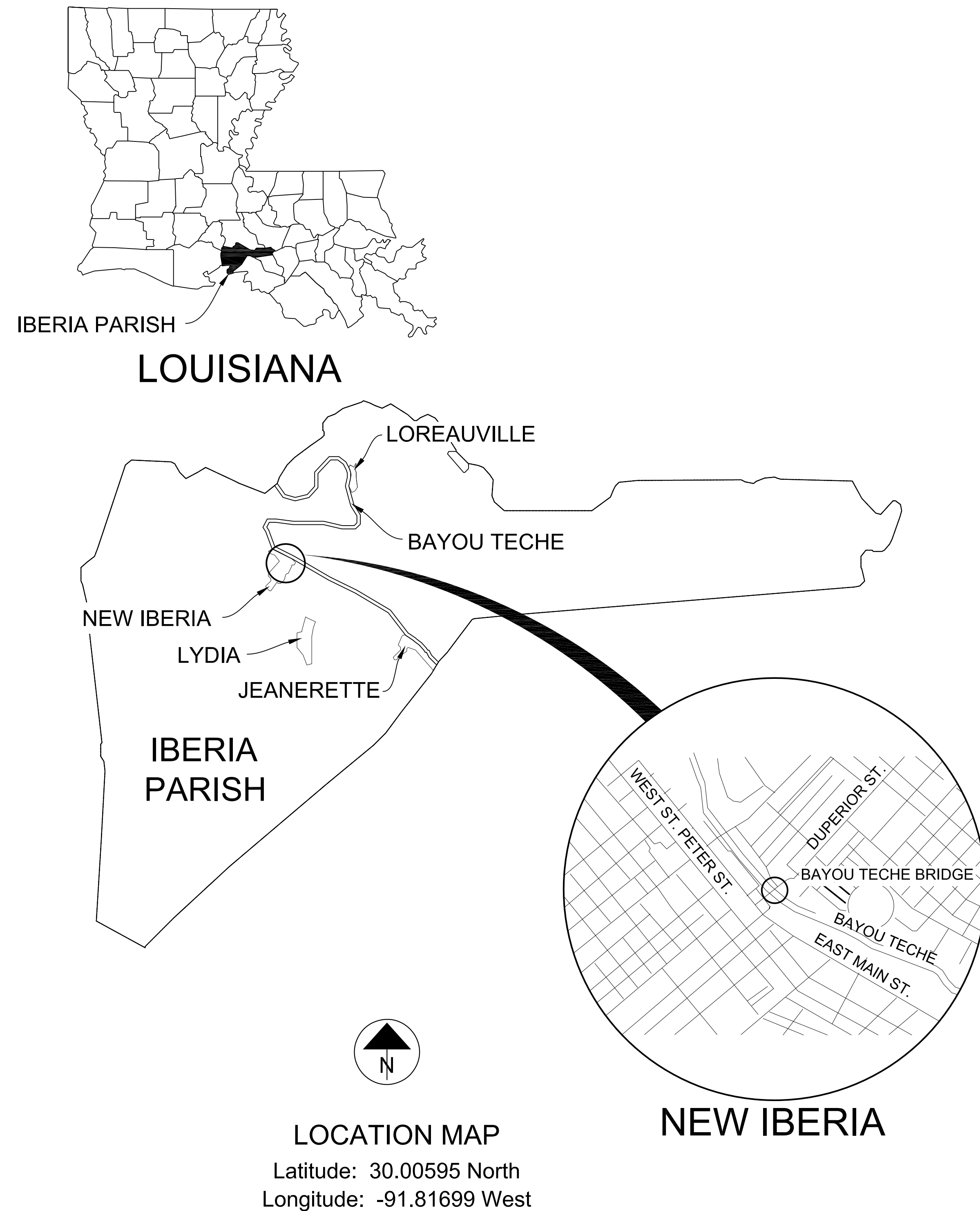

The Bayou Teche Bridge (Bridge Recall No. 005800), designed by the Louisiana Highway Commission and constructed in 1940, is a distinctive example of the bascule type. As a Scherzer-type, rolling-lift, bascule bridge its significance is demonstrated by the presence of distinctive engineering and design features of the rolling lift bascule bridge type, which is characterized by two opposing bascule leaves that roll to open. Each leaf is balanced by a rear counterweight that descends as each leaf rolls and lifts. This bridge was determined eligible for listing in the National Register of Historic Places in 2013 under *criterion c: design/engineering* at the state level of significance.

This documentation was prepared to fulfill Stipulation IX.5 of the Programmatic Agreement Among the Federal Highway Administration, the Louisiana Department of Transportation and Development, the Advisory Council on Historic Preservation, and the Louisiana State Historic Preservation Officer Regarding Management of Historic Bridges in Louisiana, dated August 18, 2015 and executed September 21, 2015. The Louisiana Department of Transportation and Development (LADOTD) retained Mead & Hunt to prepare this document. It was prepared by Katie Ohland, Cultural Resource Specialist, and Justin Duffie, Design Technician, of Mead & Hunt. Dietrich Floeter completed the photography.

The measured drawings were prepared based on a site visit to the bridge to confirm as-built plans and perform selective hand measuring in the field to verify measurements.

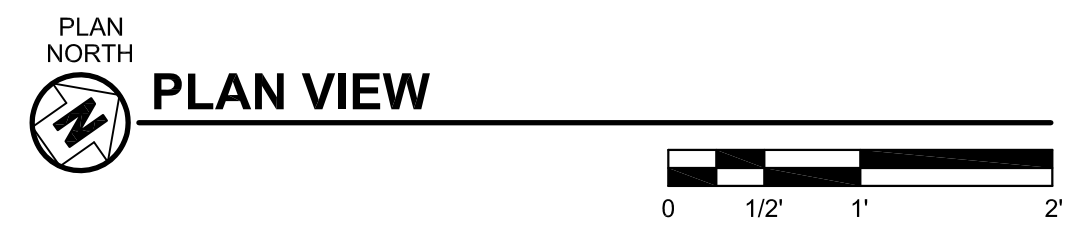
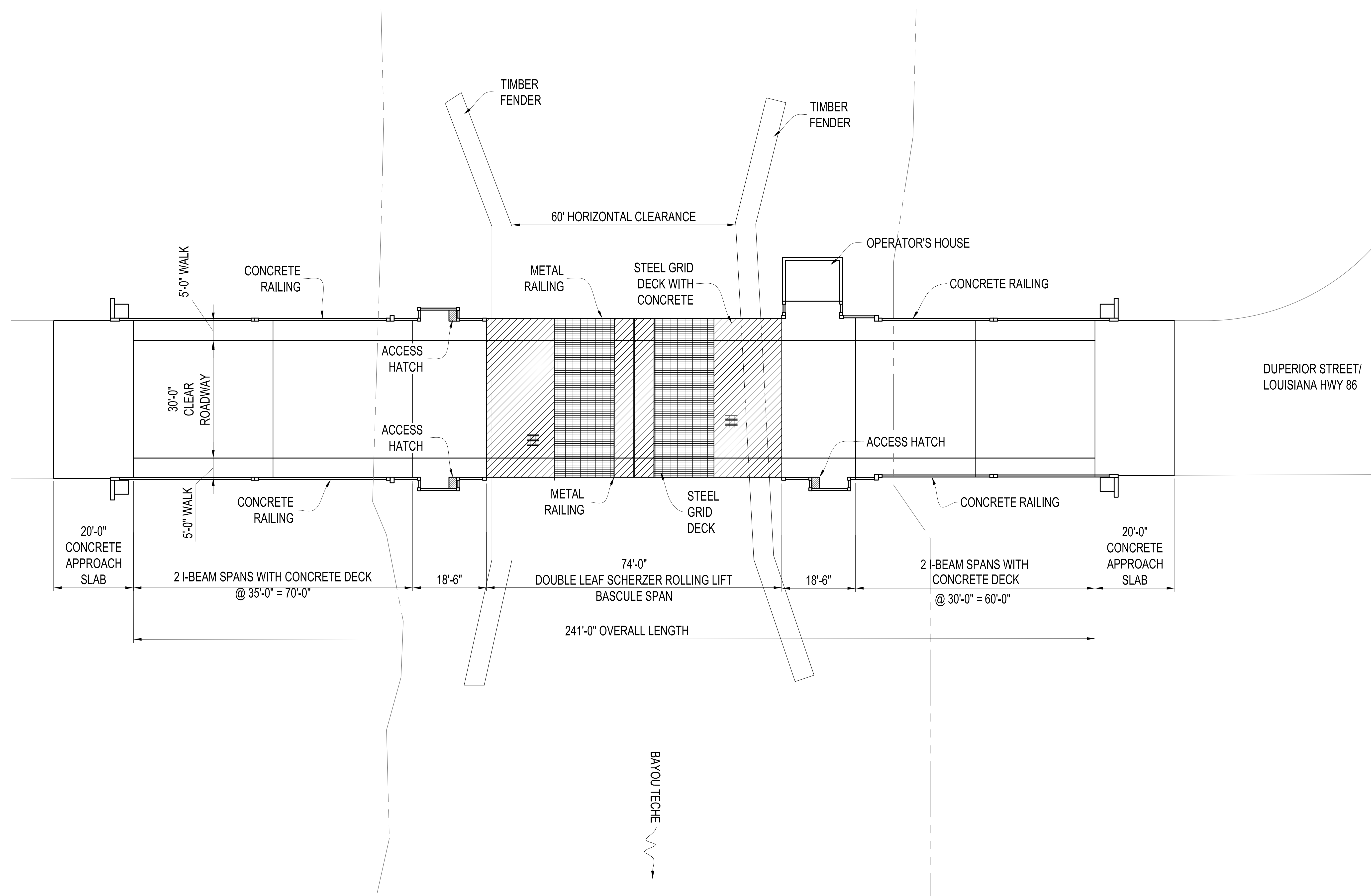

DELINEATED BY: J. DUFFIE, MEAD & HUNT, INC., 2017

LOUISIANA HISTORIC
BRIDGE INVENTORY
NATIONAL PARK SERVICE
UNITED STATES DEPARTMENT OF THE INTERIOR

NEW IBERIA

BAYOU TECHE BRIDGE
CARRIES LOUISIANA HIGHWAY 86 (LA 86) OVER BAYOU TECHE
IBERIA PARISH

LOUISIANA

SHEET
2 OF 4

HISTORIC AMERICAN
ENGINEERING RECORD
LA-29

LIBRARY OF CONGRESS
INDEX NUMBER

IF REPRODUCED, PLEASE CREDIT THE HISTORIC AMERICAN ENGINEERING RECORD, NATIONAL PARK SERVICE, NAME OF DELINEATOR, DATE OF DRAWING

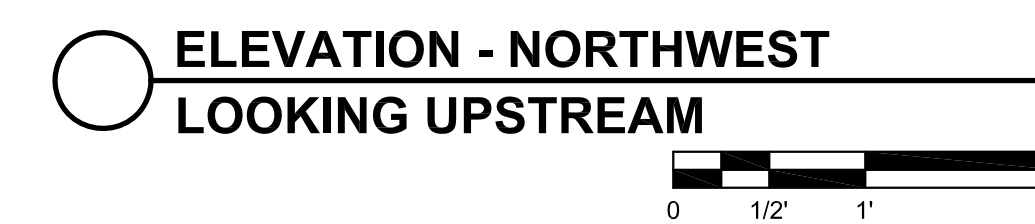
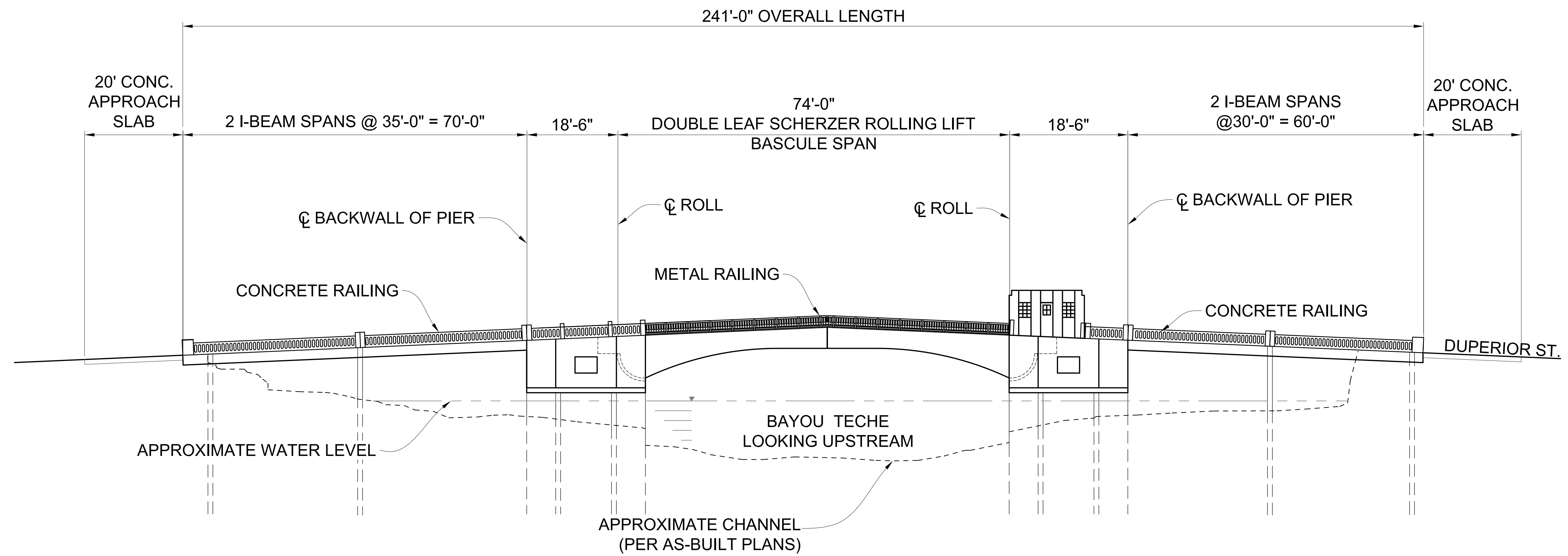

DELINEATED BY: J. DUFFIE, MEAD & HUNT, INC., 2017

LOUISIANA HISTORIC
BRIDGE INVENTORY
NATIONAL PARK SERVICE
UNITED STATES DEPARTMENT OF THE INTERIOR

NEW IBERIA

BAYOU TECHE BRIDGE
CARRIES LOUISIANA HIGHWAY 86 (LA 86) OVER BAYOU TECHE
IBERIA PARISH

LOUISIANA

SHEET
3 OF 4

HISTORIC AMERICAN
ENGINEERING RECORD
LA-29

LIBRARY OF CONGRESS
INDEX NUMBER

IF REPRODUCED, PLEASE CREDIT THE HISTORIC AMERICAN ENGINEERING RECORD, NATIONAL PARK SERVICE, NAME OF DELINEATOR, DATE OF DRAWING

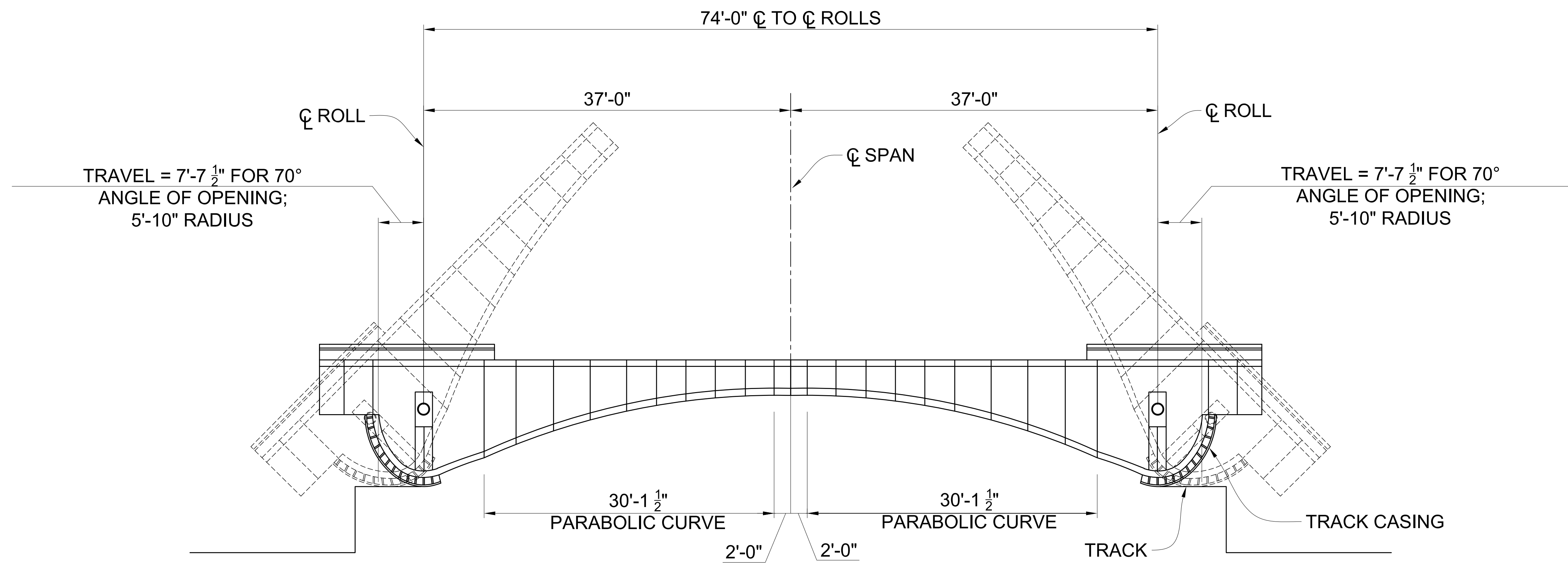

BASCULE SPAN DETAILS

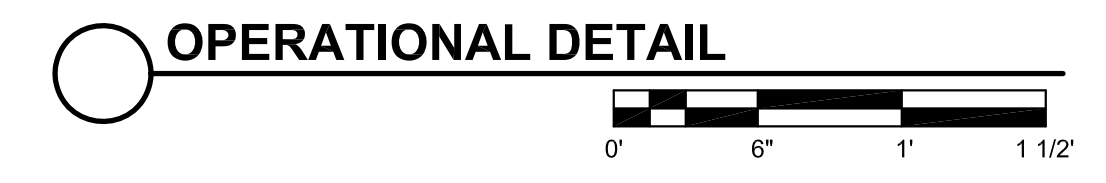

DELINEATED BY: J. DUFFIE, MEAD & HUNT, INC., 2017

LOUISIANA HISTORIC
BRIDGE INVENTORY
NATIONAL PARK SERVICE
UNITED STATES DEPARTMENT OF THE INTERIOR

NEW IBERIA

BAYOU TECHE BRIDGE
CARRIES LOUISIANA HIGHWAY 86 (LA 86) OVER BAYOU TECHE
IBERIA PARISH

LOUISIANA

SHEET
4 OF 4

HISTORIC AMERICAN
ENGINEERING RECORD
LA-29

LIBRARY OF CONGRESS
INDEX NUMBER

IF REPRODUCED, PLEASE CREDIT THE HISTORIC AMERICAN ENGINEERING RECORD, NATIONAL PARK SERVICE, NAME OF DELINEATOR, DATE OF DRAWING

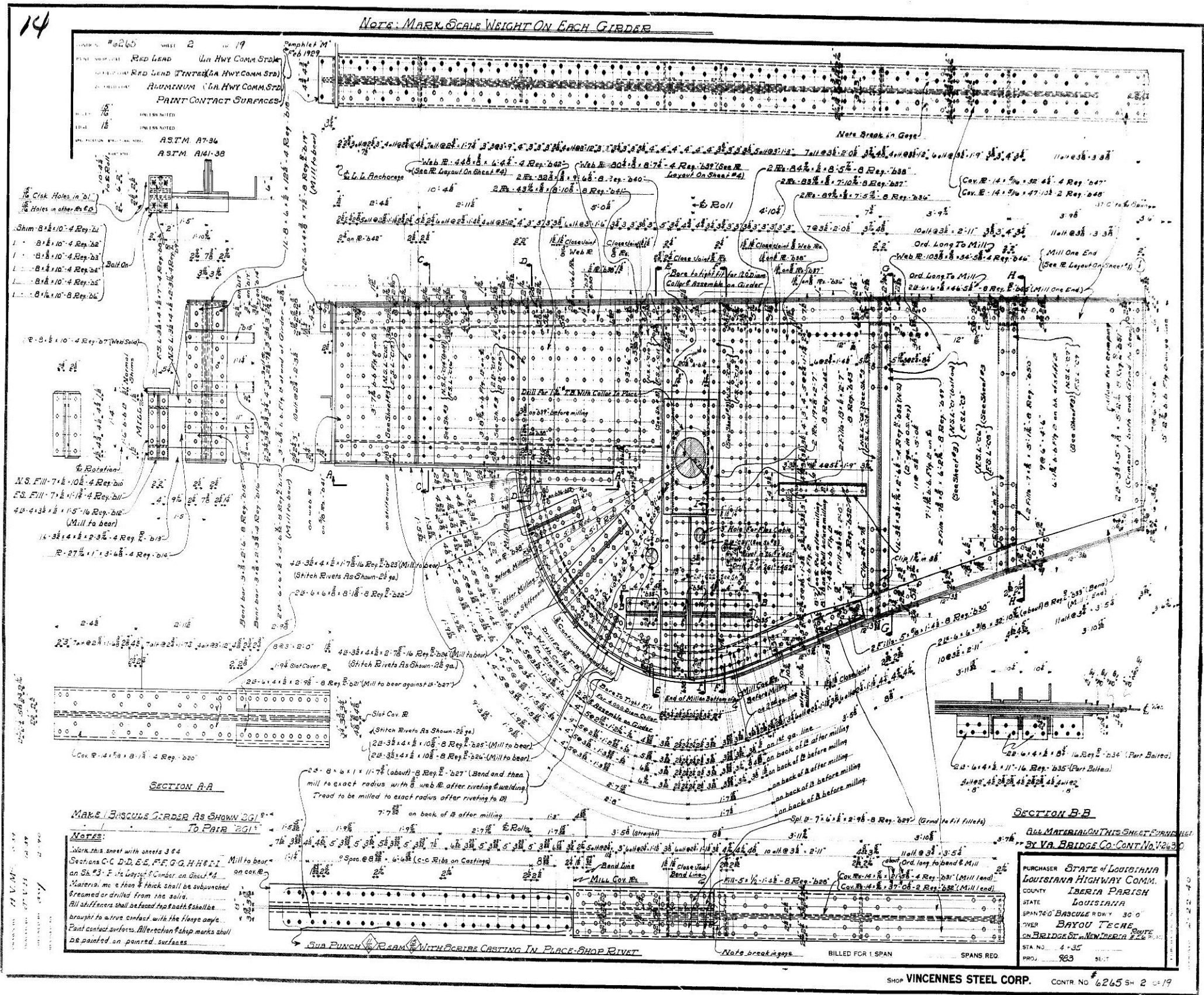

14

NOTE: MARK SCALE WEIGHT ON EACH GIRDER

SHEET NO. 2 OF 19
 CONTRACT NO. 6265
 DRAWING NO. 2
 DATE 11/19/57
 UNLESS NOTED
 ASTM A7-36
 ASTM A141-38

FINISH SURFACE: RED LEAD (IN HWY COMM. STD.)
 INTERIOR SURFACE: RED LEAD (IN HWY COMM. STD.)
 EXTERIOR SURFACE: ALUMINUM (IN HWY COMM. STD.)
 PAINT CONTACT SURFACES

Shim 8 1/2 x 10 - 4 Req. 24
 1 - 8 1/2 x 10 - 4 Req. 24
 1 - 8 1/2 x 10 - 4 Req. 24
 1 - 8 1/2 x 10 - 4 Req. 24
 1 - 8 1/2 x 10 - 4 Req. 24

6 Rotation:
 N.S. Mill 7 1/2 x 10 1/2 - 4 Req. 24
 E.S. Mill 7 1/2 x 10 1/2 - 4 Req. 24
 4B-4 3/8 x 1 1/2 - 16 Req. 24
 (Mill to bear)
 16-3/8 x 4 1/2 x 2 3/8 - 4 Req. 24
 R-27 1/2 x 1 1/2 - 8 Req. 24

SECTION A-A
 MAKE BASCULE GIRDER AS SHOWN TO PAIR TO PAIR 2G1

Notes:
 1. Mark this sheet with sheets 3 & 4
 2. Sections C-C, D-D, E-E, F-F, G-G, H-H, I-I Mill to bear on Cox R.
 3. Material more than 1/2" thick shall be subcutted, beamed or drilled from the solid.
 4. All stiffeners shall be defaced top & bottom flanges brought to a true contact with the flange angle.
 5. Paint contact surfaces. All section & shop marks shall be painted on painted surfaces.

SUB PUNCH RIVETS WITH SCRIBES CASTING IN PLACE SHOP RIVET

SECTION B-B
 ALL MATERIAL ON THIS SHEET FURNISHED BY VA. BRIDGE CO. CONT. NO. 1243

PURCHASER	STATE OF LOUISIANA
	LOUISIANA HIGHWAY COMM.
COUNTY	IBERIA PARISH
STATE	LOUISIANA
SPAN	740' BASCULE ROAD 30'
OVER	BAYOU TEXE
ON	BRIDGE ON NEW ORLEANS FREEWAY
STA NO.	4+35
PROJ.	963

SHOP VINCENNES STEEL CORP. CONTR NO. 6265 S-2 OF 19



SHOP DRAWINGS

66

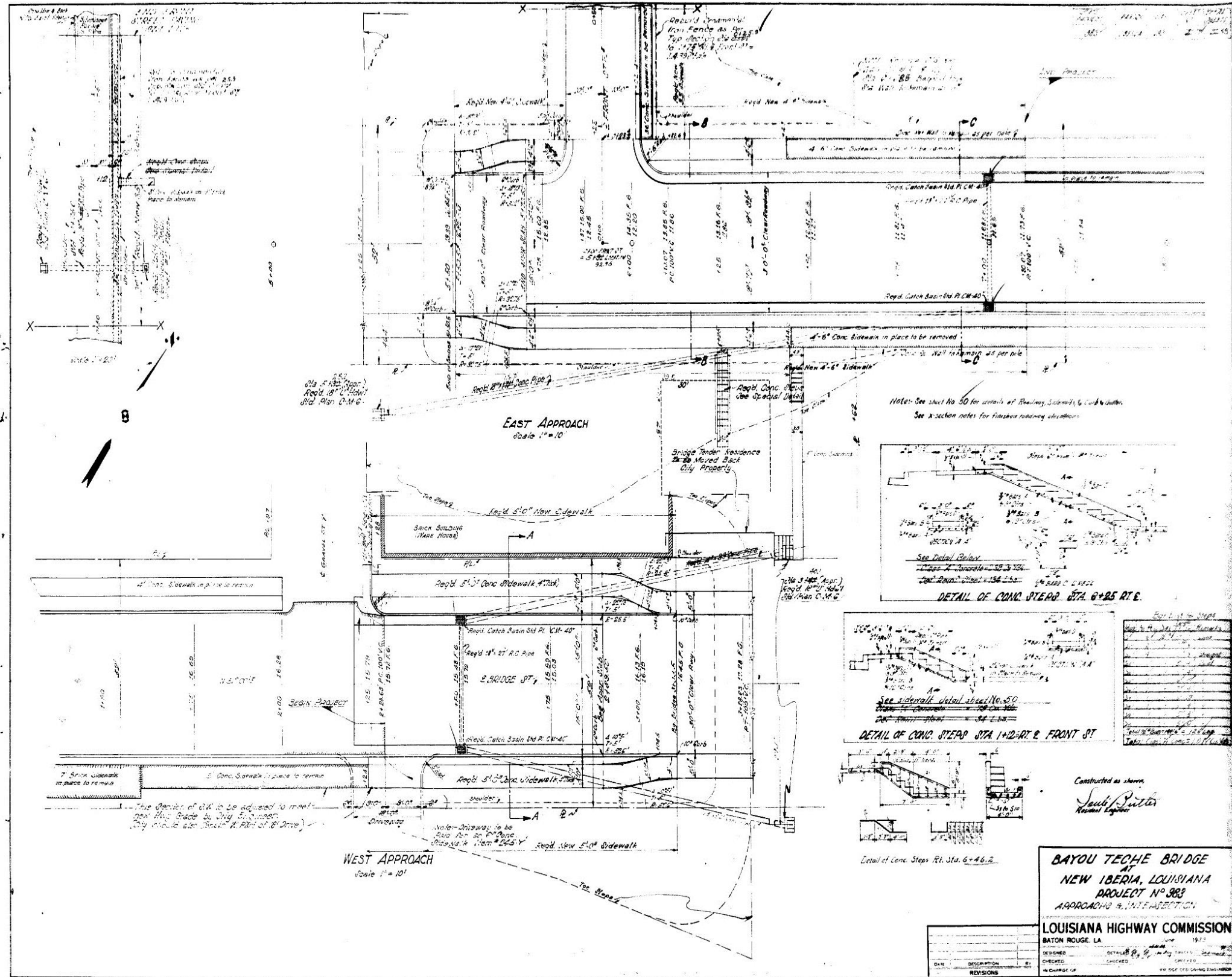

AS BUILT PLANS

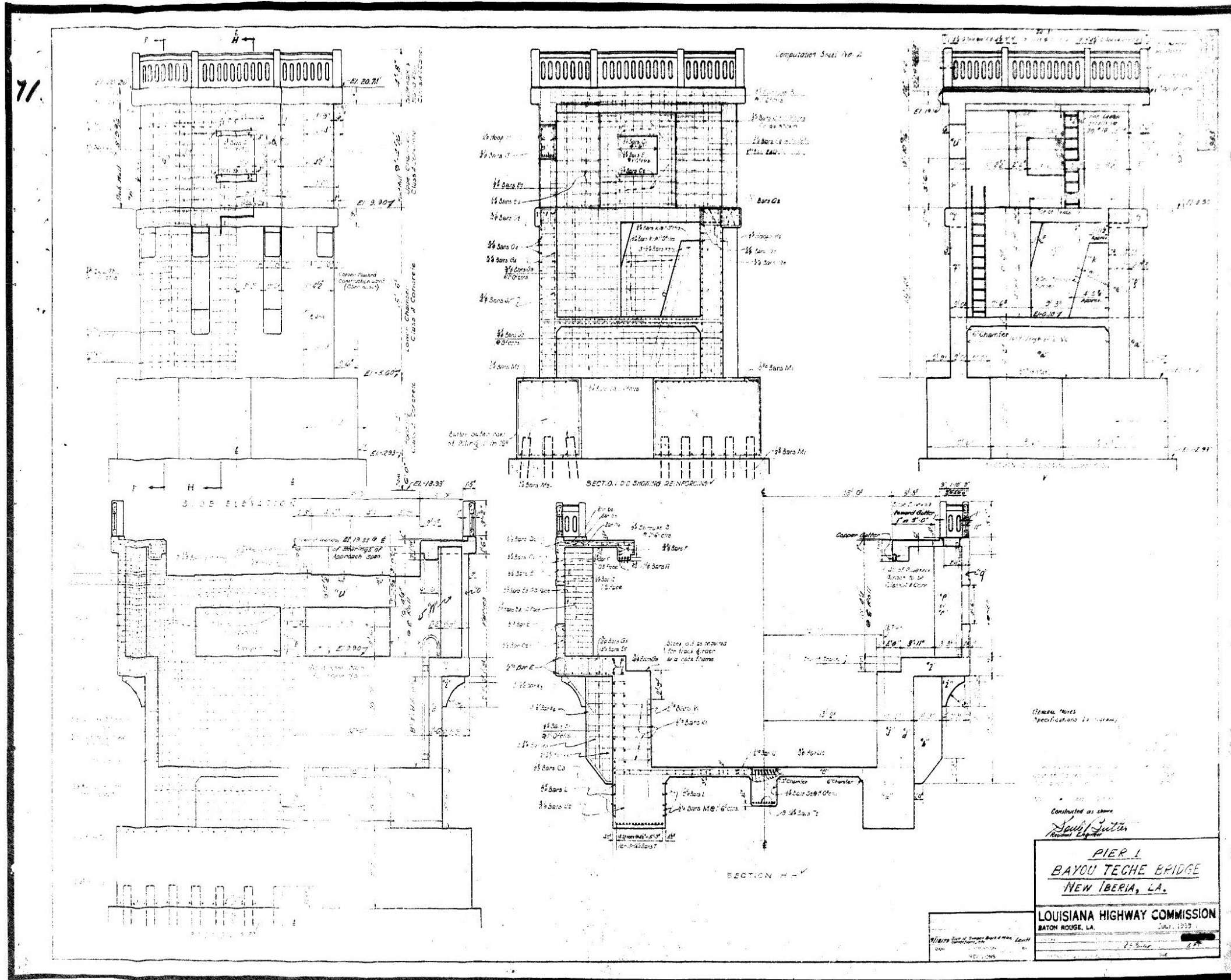

AS BUILT PLANS

72

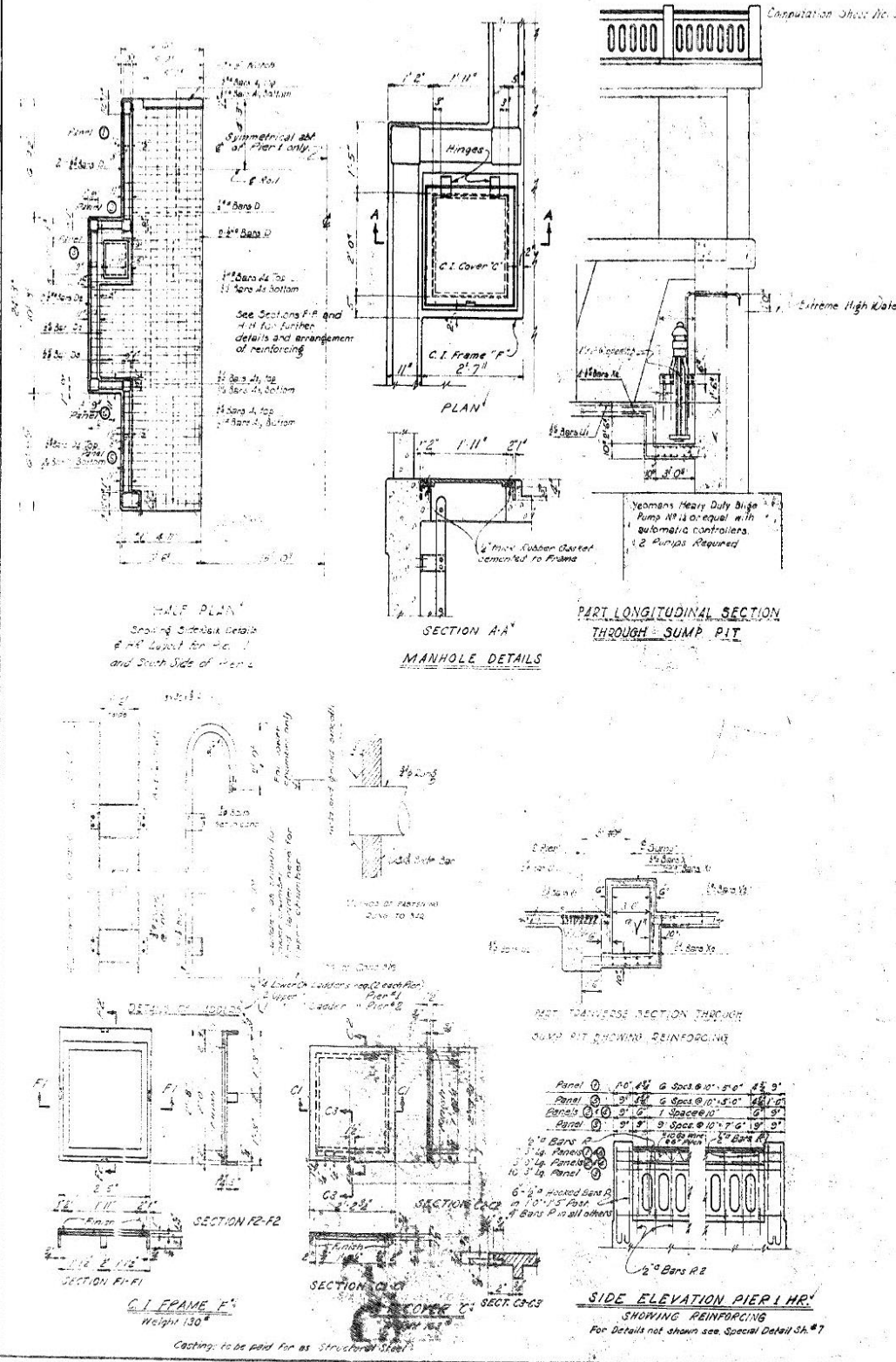

73

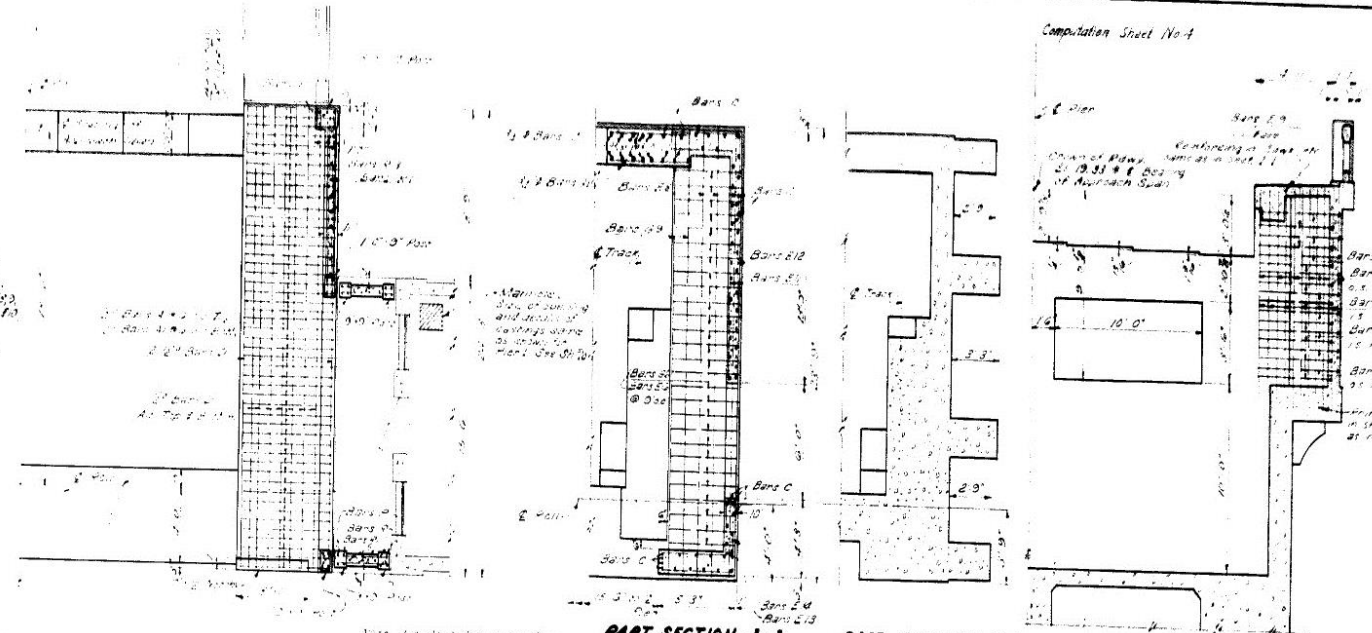

Computation Sheet No 4

BILL OF MATERIALS										
41	77	8 0	0 0	0	0	0	0	0	0	0
42	77	0 0	0 0	0	0	0	0	0	0	0
43	10	10 7	10 0	0	0	0	0	0	0	0
44	10	8 9	10 0	0	0	0	0	0	0	0
45	5	5 0	0 0	0	0	0	0	0	0	0
46	5	5 0	0 0	0	0	0	0	0	0	0
47	9	9 0	0 0	0	0	0	0	0	0	0
48	9	9 0	0 0	0	0	0	0	0	0	0
49	12	12 0	0 0	0	0	0	0	0	0	0
50	20	20 0	0 0	0	0	0	0	0	0	0
51	3	3 0	0 0	0	0	0	0	0	0	0
52	3	3 0	0 0	0	0	0	0	0	0	0
53	3	3 0	0 0	0	0	0	0	0	0	0
54	7	7 0	0 0	0	0	0	0	0	0	0
55	10	10 0	0 0	0	0	0	0	0	0	0
56	20	20 0	0 0	0	0	0	0	0	0	0
57	20	20 0	0 0	0	0	0	0	0	0	0
58	20	20 0	0 0	0	0	0	0	0	0	0
59	20	20 0	0 0	0	0	0	0	0	0	0
60	20	20 0	0 0	0	0	0	0	0	0	0
61	20	20 0	0 0	0	0	0	0	0	0	0
62	20	20 0	0 0	0	0	0	0	0	0	0
63	20	20 0	0 0	0	0	0	0	0	0	0
64	20	20 0	0 0	0	0	0	0	0	0	0
65	20	20 0	0 0	0	0	0	0	0	0	0
66	20	20 0	0 0	0	0	0	0	0	0	0
67	20	20 0	0 0	0	0	0	0	0	0	0
68	20	20 0	0 0	0	0	0	0	0	0	0
69	20	20 0	0 0	0	0	0	0	0	0	0
70	20	20 0	0 0	0	0	0	0	0	0	0
71	20	20 0	0 0	0	0	0	0	0	0	0
72	20	20 0	0 0	0	0	0	0	0	0	0
73	20	20 0	0 0	0	0	0	0	0	0	0
74	20	20 0	0 0	0	0	0	0	0	0	0
75	20	20 0	0 0	0	0	0	0	0	0	0
76	20	20 0	0 0	0	0	0	0	0	0	0
77	20	20 0	0 0	0	0	0	0	0	0	0
78	20	20 0	0 0	0	0	0	0	0	0	0
79	20	20 0	0 0	0	0	0	0	0	0	0
80	20	20 0	0 0	0	0	0	0	0	0	0
81	20	20 0	0 0	0	0	0	0	0	0	0
82	20	20 0	0 0	0	0	0	0	0	0	0
83	20	20 0	0 0	0	0	0	0	0	0	0
84	20	20 0	0 0	0	0	0	0	0	0	0
85	20	20 0	0 0	0	0	0	0	0	0	0
86	20	20 0	0 0	0	0	0	0	0	0	0
87	20	20 0	0 0	0	0	0	0	0	0	0
88	20	20 0	0 0	0	0	0	0	0	0	0
89	20	20 0	0 0	0	0	0	0	0	0	0
90	20	20 0	0 0	0	0	0	0	0	0	0
91	20	20 0	0 0	0	0	0	0	0	0	0
92	20	20 0	0 0	0	0	0	0	0	0	0
93	20	20 0	0 0	0	0	0	0	0	0	0
94	20	20 0	0 0	0	0	0	0	0	0	0
95	20	20 0	0 0	0	0	0	0	0	0	0
96	20	20 0	0 0	0	0	0	0	0	0	0
97	20	20 0	0 0	0	0	0	0	0	0	0
98	20	20 0	0 0	0	0	0	0	0	0	0
99	20	20 0	0 0	0	0	0	0	0	0	0
100	20	20 0	0 0	0	0	0	0	0	0	0

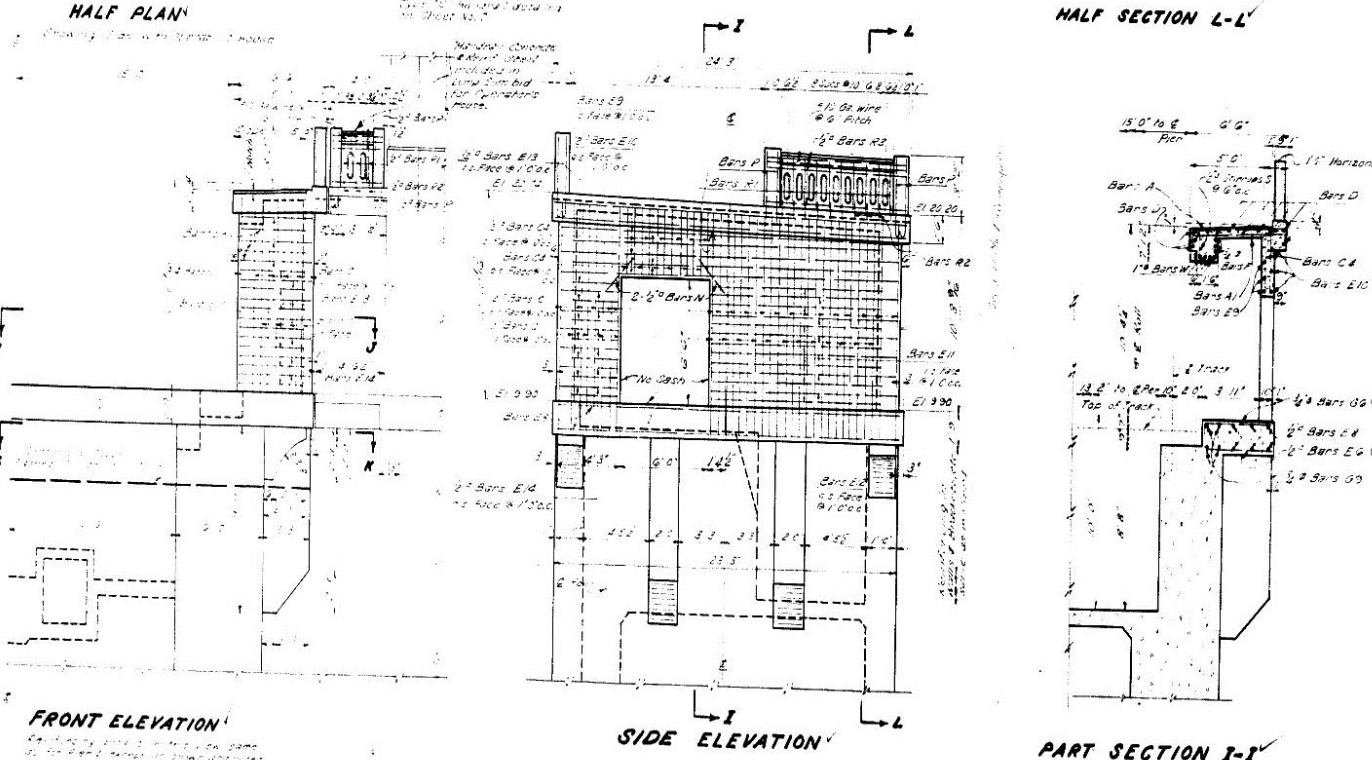

NOTE: Actual Views for Pier # 2 are opposite about E of Bridge to those shown on this Sheet.

GENERAL NOTES: Same as for Pier 1. See Sheet No. 3. All details of Pier 2 same as Pier 1 except as shown and noted.

Constructed as shown.
Louis Dubois
Resident Engineer

PIER 2
BAYOU TEGHE BRIDGE
NEW IBERIA, LA.
LOUISIANA HIGHWAY COMMISSION
BATON ROUGE, LA. JULY, 1939



AS BUILT PLANS

75

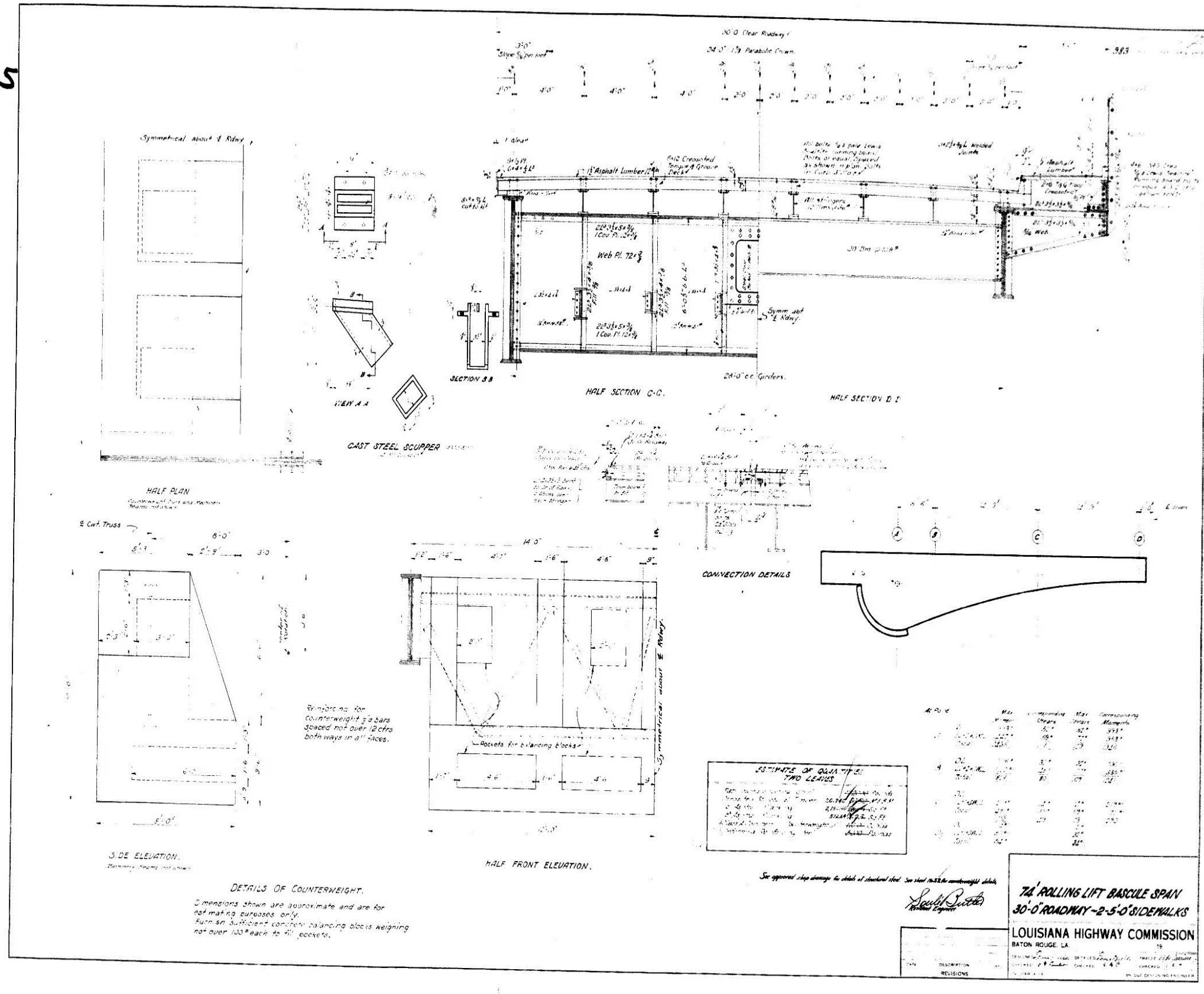

AS BUILT PLANS



86

UPPER FLOOR PLAN
SECTION 8-B

FRONT ELEVATION

REAR ELEVATION

SECTION 1-1

STANDARD PLAN
OPERATORS HOUSE
OPERATORS & MACHINERY HOUSE

LOUISIANA HIGHWAY COMMISSION
BATON ROUGE, LA.

1940 P&O PROP. BY T&O

Constructed as shown.
Resident Engineer

C-M-16B



AS BUILT PLANS



Job No. _____ Sheet _____ of _____

Job Name 005800

Task Misc Details

Calculated by _____ Date _____

Checked by _____ Date _____

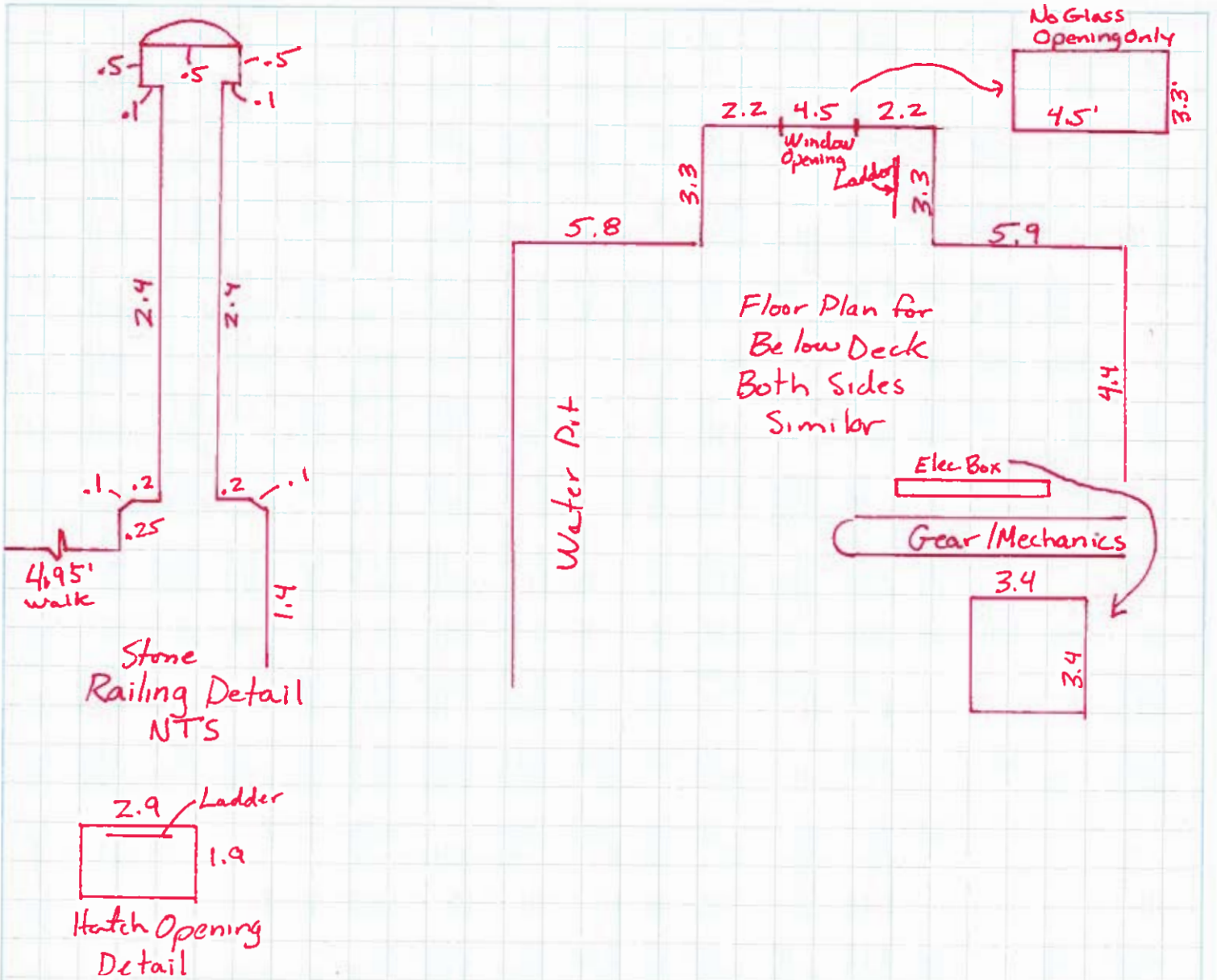

Mead & Hunt

Mead & Hunt, Inc.

Job No. _____ Sheet _____ of _____

Job Name 005800

Task Top Railing Detail - Stone

Calculated by _____ Date _____

Checked by _____ Date _____

Bayou

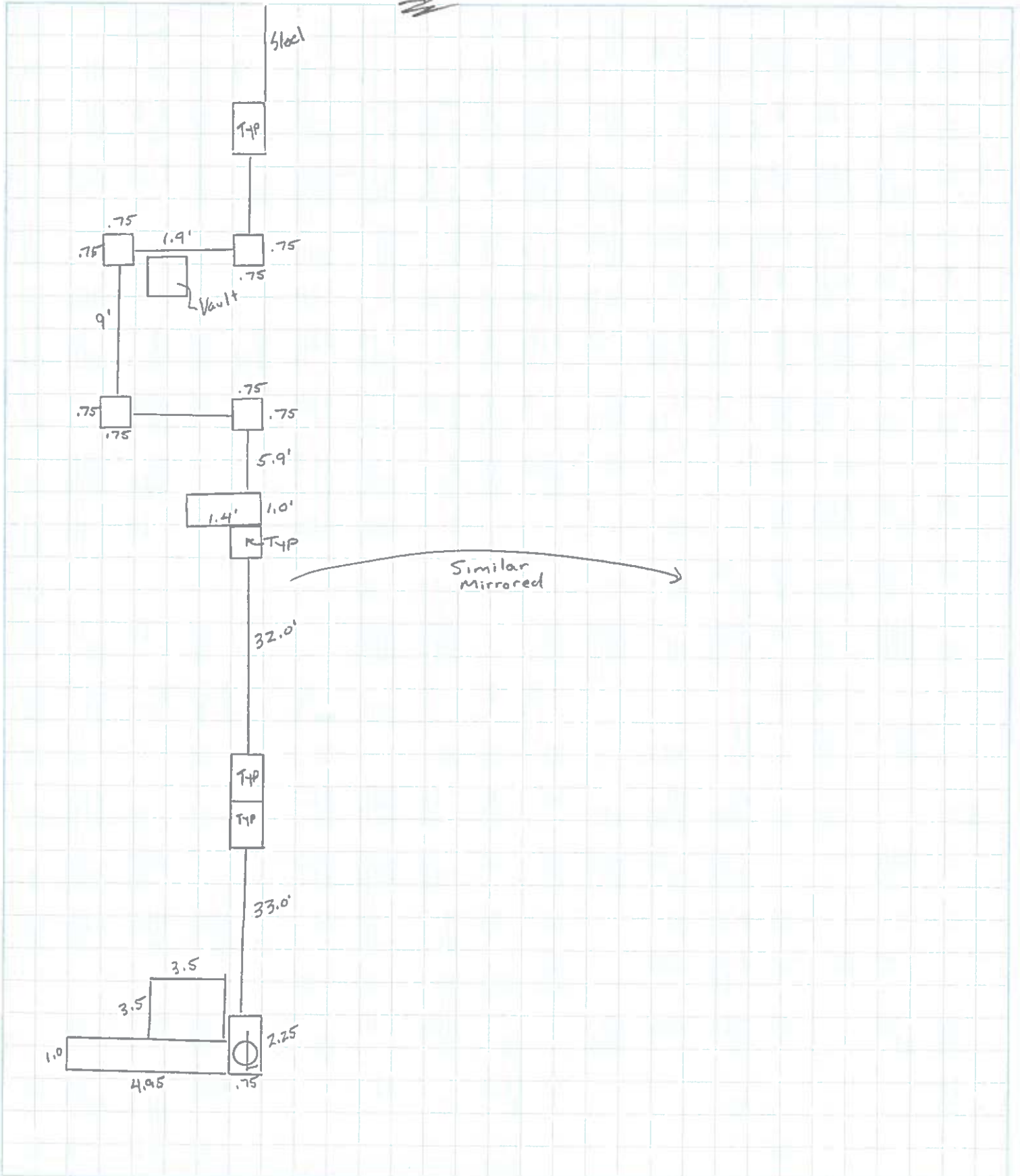

Similar mirrored →



Job No. _____ Sheet _____ of _____

Job Name 005800

Task Top Railing Detail - Stone

Calculated by _____ Date _____

Checked by _____ Date _____

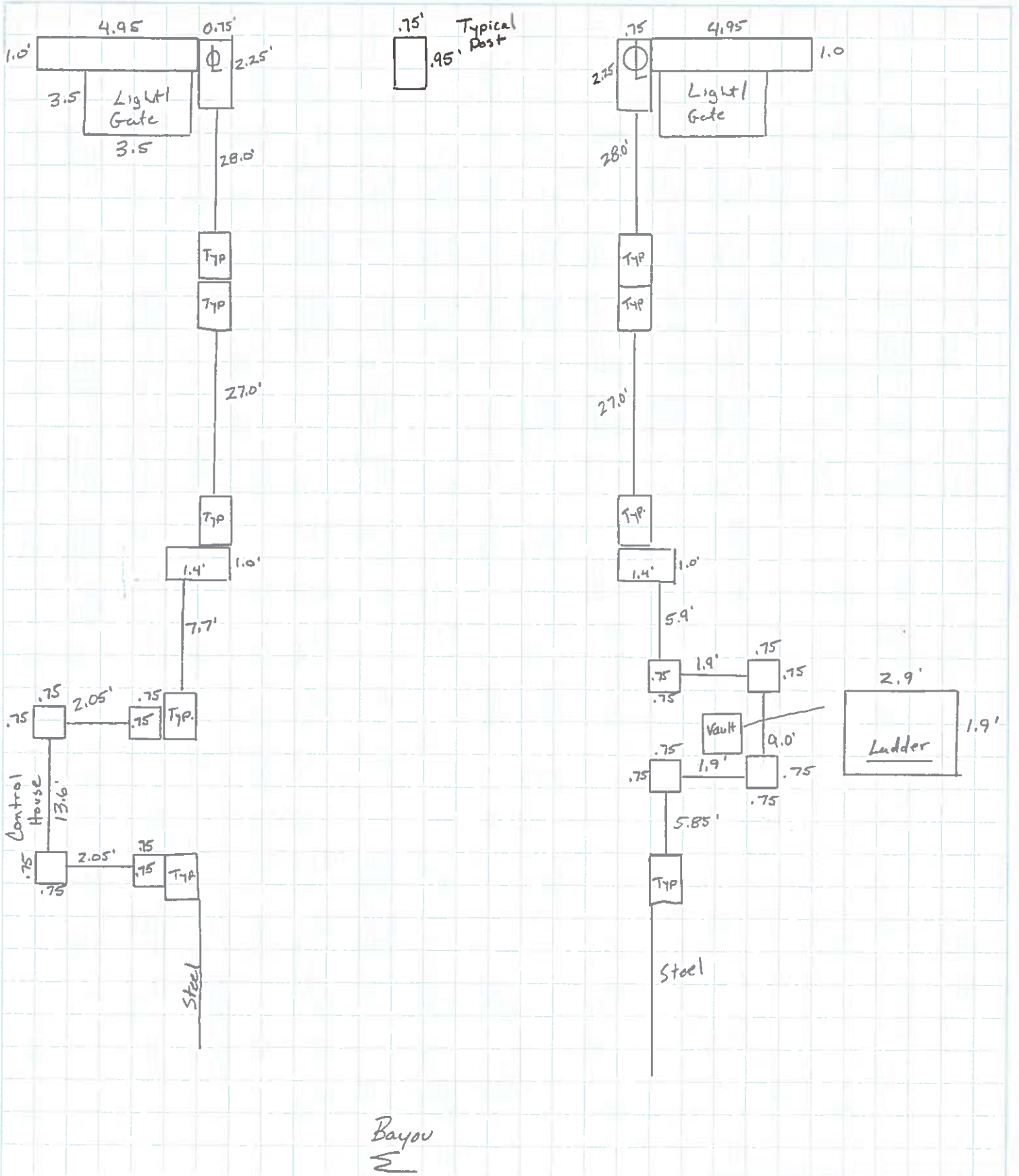



Job No. _____ Sheet _____ of _____

Job Name 005800

Task Stone Elevation Detail

Calculated by _____ Date _____

Checked by _____ Date _____

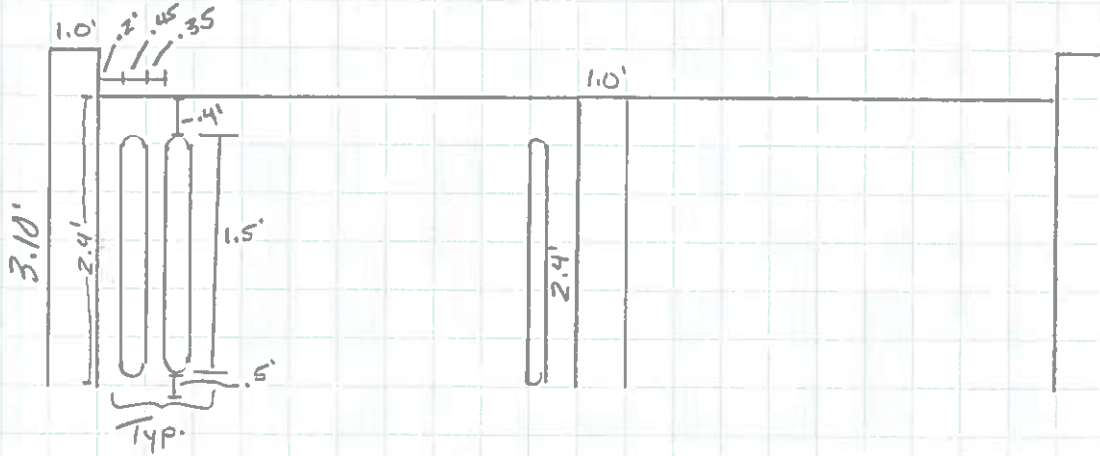

Top View All 4 Sides



Typical Elevation

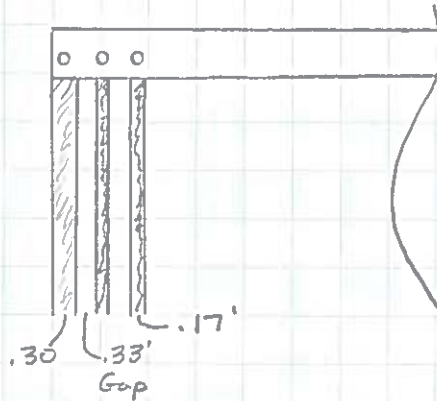

PLAN AND PROFILE OF PROPOSED STATE HIGHWAY

BAYOU TECHE BRIDGE
STATE ROUTE NO 56
AT NEW IBERIA, LA
IBERIA PARISH

STATE PROJECT 983

by DJB
2/16/2016

Iberia Parish
Bridge 005800
Double Leaf Bascule
Sheet 1 of ~~10~~ 11

LAYOUT MAP ONLY
DESIGNED BY
DRAWN BY
CHECKED BY
DATE

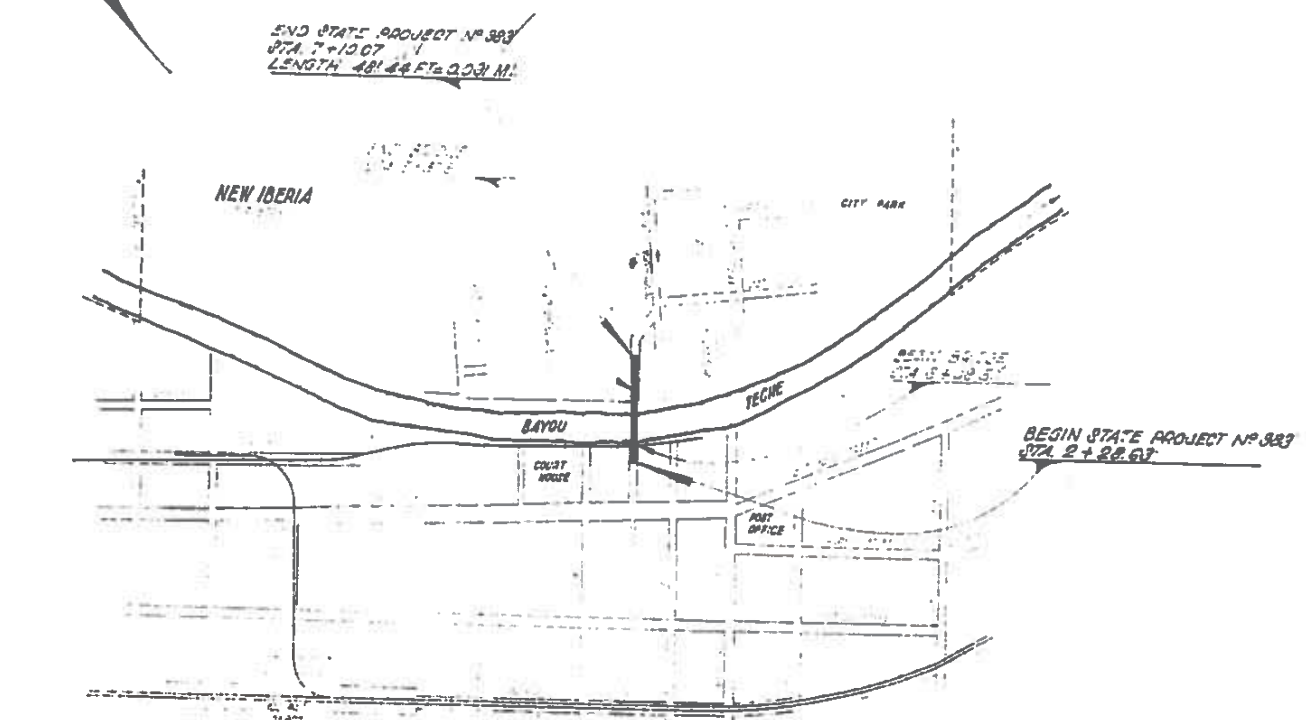

CONVENTIONAL SIGNS

1	2	3	4	5	6	7	8	9	10	11	12	13	14	15	16	17	18	19	20	21	22	23	24	25	26	27	28	29	30	31	32	33	34	35	36	37	38	39	40	41	42	43	44	45	46	47	48	49	50	51	52	53	54	55	56	57	58	59	60	61	62	63	64	65	66	67	68	69	70	71	72	73	74	75	76	77	78	79	80	81	82	83	84	85	86	87	88	89	90	91	92	93	94	95	96	97	98	99	100
---	---	---	---	---	---	---	---	---	----	----	----	----	----	----	----	----	----	----	----	----	----	----	----	----	----	----	----	----	----	----	----	----	----	----	----	----	----	----	----	----	----	----	----	----	----	----	----	----	----	----	----	----	----	----	----	----	----	----	----	----	----	----	----	----	----	----	----	----	----	----	----	----	----	----	----	----	----	----	----	----	----	----	----	----	----	----	----	----	----	----	----	----	----	----	----	----	----	----	-----

LAYOUT MAP
SCALE 1 INCH = 400 FEET

LENGTH OF STATE PROJECT 983		
STA TO STA	RCARRRY BRIDGE	
	FEET	FEET
0+00 TO 0+21	100	100
0+21 TO 0+42	100	100
0+42 TO 0+63	100	100
0+63 TO 0+84	100	100
0+84 TO 1+05	100	100
1+05 TO 1+26	100	100
1+26 TO 1+47	100	100
1+47 TO 1+68	100	100
1+68 TO 1+89	100	100
1+89 TO 2+10	100	100
2+10 TO 2+31	100	100
2+31 TO 2+52	100	100
2+52 TO 2+73	100	100
2+73 TO 2+94	100	100
2+94 TO 3+15	100	100
3+15 TO 3+36	100	100
3+36 TO 3+57	100	100
3+57 TO 3+78	100	100
3+78 TO 3+99	100	100
3+99 TO 4+20	100	100
4+20 TO 4+41	100	100
4+41 TO 4+62	100	100
4+62 TO 4+83	100	100
4+83 TO 5+04	100	100
5+04 TO 5+25	100	100
5+25 TO 5+46	100	100
5+46 TO 5+67	100	100
5+67 TO 5+88	100	100
5+88 TO 6+09	100	100
6+09 TO 6+30	100	100
6+30 TO 6+51	100	100
6+51 TO 6+72	100	100
6+72 TO 6+93	100	100
6+93 TO 7+14	100	100
7+14 TO 7+35	100	100
7+35 TO 7+56	100	100
7+56 TO 7+77	100	100
7+77 TO 7+98	100	100
7+98 TO 8+19	100	100
8+19 TO 8+40	100	100
8+40 TO 8+61	100	100
8+61 TO 8+82	100	100
8+82 TO 9+03	100	100
9+03 TO 9+24	100	100
9+24 TO 9+45	100	100
9+45 TO 9+66	100	100
9+66 TO 9+87	100	100
9+87 TO 10+08	100	100
10+08 TO 10+29	100	100
10+29 TO 10+50	100	100
10+50 TO 10+71	100	100
10+71 TO 10+92	100	100
10+92 TO 11+13	100	100
11+13 TO 11+34	100	100
11+34 TO 11+55	100	100
11+55 TO 11+76	100	100
11+76 TO 11+97	100	100
11+97 TO 12+18	100	100
12+18 TO 12+39	100	100
12+39 TO 12+60	100	100
12+60 TO 12+81	100	100
12+81 TO 13+02	100	100
13+02 TO 13+23	100	100
13+23 TO 13+44	100	100
13+44 TO 13+65	100	100
13+65 TO 13+86	100	100
13+86 TO 14+07	100	100
14+07 TO 14+28	100	100
14+28 TO 14+49	100	100
14+49 TO 14+70	100	100
14+70 TO 14+91	100	100
14+91 TO 15+12	100	100
15+12 TO 15+33	100	100
15+33 TO 15+54	100	100
15+54 TO 15+75	100	100
15+75 TO 15+96	100	100
15+96 TO 16+17	100	100
16+17 TO 16+38	100	100
16+38 TO 16+59	100	100
16+59 TO 16+80	100	100
16+80 TO 17+01	100	100
17+01 TO 17+22	100	100
17+22 TO 17+43	100	100
17+43 TO 17+64	100	100
17+64 TO 17+85	100	100
17+85 TO 18+06	100	100
18+06 TO 18+27	100	100
18+27 TO 18+48	100	100
18+48 TO 18+69	100	100
18+69 TO 18+90	100	100
18+90 TO 19+11	100	100
19+11 TO 19+32	100	100
19+32 TO 19+53	100	100
19+53 TO 19+74	100	100
19+74 TO 19+95	100	100
19+95 TO 20+16	100	100
20+16 TO 20+37	100	100
20+37 TO 20+58	100	100
20+58 TO 20+79	100	100
20+79 TO 21+00	100	100
21+00 TO 21+21	100	100
21+21 TO 21+42	100	100
21+42 TO 21+63	100	100
21+63 TO 21+84	100	100
21+84 TO 22+05	100	100
22+05 TO 22+26	100	100
22+26 TO 22+47	100	100
22+47 TO 22+68	100	100
22+68 TO 22+89	100	100
22+89 TO 23+10	100	100
23+10 TO 23+31	100	100
23+31 TO 23+52	100	100
23+52 TO 23+73	100	100
23+73 TO 23+94	100	100
23+94 TO 24+15	100	100
24+15 TO 24+36	100	100
24+36 TO 24+57	100	100
24+57 TO 24+78	100	100
24+78 TO 24+99	100	100
24+99 TO 25+20	100	100
25+20 TO 25+41	100	100
25+41 TO 25+62	100	100
25+62 TO 25+83	100	100
25+83 TO 26+04	100	100
26+04 TO 26+25	100	100
26+25 TO 26+46	100	100
26+46 TO 26+67	100	100
26+67 TO 26+88	100	100
26+88 TO 27+09	100	100
27+09 TO 27+30	100	100
27+30 TO 27+51	100	100
27+51 TO 27+72	100	100
27+72 TO 27+93	100	100
27+93 TO 28+14	100	100
28+14 TO 28+35	100	100
28+35 TO 28+56	100	100
28+56 TO 28+77	100	100
28+77 TO 28+98	100	100
28+98 TO 29+19	100	100
29+19 TO 29+40	100	100
29+40 TO 29+61	100	100
29+61 TO 29+82	100	100
29+82 TO 30+03	100	100
30+03 TO 30+24	100	100
30+24 TO 30+45	100	100
30+45 TO 30+66	100	100
30+66 TO 30+87	100	100
30+87 TO 31+08	100	100
31+08 TO 31+29	100	100
31+29 TO 31+50	100	100
31+50 TO 31+71	100	100
31+71 TO 31+92	100	100
31+92 TO 32+13	100	100
32+13 TO 32+34	100	100
32+34 TO 32+55	100	100
32+55 TO 32+76	100	100
32+76 TO 32+97	100	100
32+97 TO 33+18	100	100
33+18 TO 33+39	100	100
33+39 TO 33+60	100	100
33+60 TO 33+81	100	100
33+81 TO 34+02	100	100
34+02 TO 34+23	100	100
34+23 TO 34+44	100	100
34+44 TO 34+65	100	100
34+65 TO 34+86	100	100
34+86 TO 35+07	100	100
35+07 TO 35+28	100	100
35+28 TO 35+49	100	100
35+49 TO 35+70	100	100
35+70 TO 35+91	100	100
35+91 TO 36+12	100	100
36+12 TO 36+33	100	100
36+33 TO 36+54	100	100
36+54 TO 36+75	100	100
36+75 TO 36+96	100	100
36+96 TO 37+17	100	100
37+17 TO 37+38	100	100
37+38 TO 37+59	100	100
37+59 TO 37+80	100	100
37+80 TO 38+01	100	100
38+01 TO 38+22	100	100
38+22 TO 38+43	100	100
38+43 TO 38+64	100	100
38+64 TO 38+85	100	100
38+85 TO 39+06	100	100
39+06 TO 39+27	100	100
39+27 TO 39+48	100	100
39+48 TO 39+69	100	100
39+69 TO 39+90	100	100
39+90 TO 40+11	100	100
40+11 TO 40+32	100	100
40+32 TO 40+53	100	100
40+53 TO 40+74	100	100
40+74 TO 40+95	100	100
40+95 TO 41+16	100	100
41+16 TO 41+37	100	100
41+37 TO 41+58	100	100
41+58 TO 41+79	100	100
41+79 TO 42+00	100	100
42+00 TO 42+21	100	100
42+21 TO 42+42	100	100
42+42 TO 42+63	100	100
42+63 TO 42+84	100	100
42+84 TO 43+05	100	100
43+05 TO 43+26	100	100
43+26 TO 43+47	100	100
43+47 TO 43+68	100	100
43+68 TO 43+89	100	100
43+89 TO 44+10	100	100
44+10 TO 44+31	100	100
44+31 TO 44+52	100	100
44+52 TO 44+73	100	100
44+73 TO 44+94	100	100
44+94 TO 45+15	100	100
45+15 TO 45+36	100	100
45+36 TO 45+57	100	100
45+57 TO 45+78	100	100
45+78 TO 45+99	100	100
45+99 TO 46+20	100	100
46+20 TO 46+41	100	100
46+41 TO 46+62	100	100
46+62 TO 46+83	100	100
46+83 TO 47+04	100	100
47+04 TO 47+25	100	100
47+25 TO 47+46	100	100
47+46 TO 47+67	100	100
47+67 TO 47+88	100	100
47+88 TO 48+09	100	100
48+09 TO 48+30	100	100
48+30 TO 48+51	100	100
48+51 TO 48+72	100	100
48+72 TO 48+93	100	100
48+93 TO 49+14	100	100
49+14 TO 49+35	100	100
49+35 TO 49+56	100	100
49+56 TO 49+77	100	100
49+77 TO 49+98	100	100
49+98 TO 50+19	100	100
50+19 TO 50+40	100	100
50+40 TO 50+61	100	100
50+61 TO 50+82	100	100
50+82 TO 51+03	100	100
51+03 TO 51+24	100	100
51+24 TO 51+45	100	100
51+45 TO 51+66	100	100
51+66 TO 51+87	100	100
51+87 TO 52+08	100	100
52+08 TO 52+29	100	100
52+29 TO 52+50	100	100
52+50 TO 52+71	100	100
52+71 TO 52+92	100	100
52+92 TO 53+13	100	100
53+13 TO 53+34	100	100
53+34 TO 53+55	100	100
53+55 TO 53+76	100	100
53+76 TO 53+97	100	100
53+97 TO 54+18	100	100
54+18 TO 54+39	100	100
54+39 TO 54+60	100	100
54+60 TO 54+81	100	100
54+81 TO 55+02	100	100
55+02 TO 55+23	100	100
55+23 TO 55+44	100	100
55+44 TO 55+65	100	100
55+65 TO 55+86	100	100
55+86 TO 56+07	100	100
56+07 TO 56+28	100	100
56+28 TO 56+49	100	100
56+49 TO 56+70	100	100
56+70 TO 56+91	100	100
56+91 TO 57+12	100	100
57+12 TO 57+33	100	100
57+33 TO 57+54	100	100
57+54 TO 57+75	100	100
57+75 TO 57+96	100	100
57+96 TO 58+17	100	100
58+17 TO 58+38	100	100
58+38 TO 58+59	100	100
58+59 TO 58+80	100	100
58+80 TO 59+01	100	100
59+01 TO 59+22	100	100
59+22 TO 59+43	100	100
59+43 TO 59+64	100	100
59+64 TO 59+85	100	100
59+85 TO 60+06	100	100
60+06 TO 60+27	100	100
60+27 TO 60+48	100	100
60+48 TO 60+69	100	100
60+69 TO 60+90	100	100
60+90 TO 61+11	100	100
61+11 TO 61+32	100	100
61+32 TO 61+53	100	100
61+53 TO 61+74	100	100
61+74 TO 61+95	100	100
61+95 TO 62+16	100	100
62+16 TO 62+37	100	100
62+37 TO 62+58	100	100

103

Iberia Parish
Bridge 005800
Double Leaf Bascule
Sheet 2 of 11

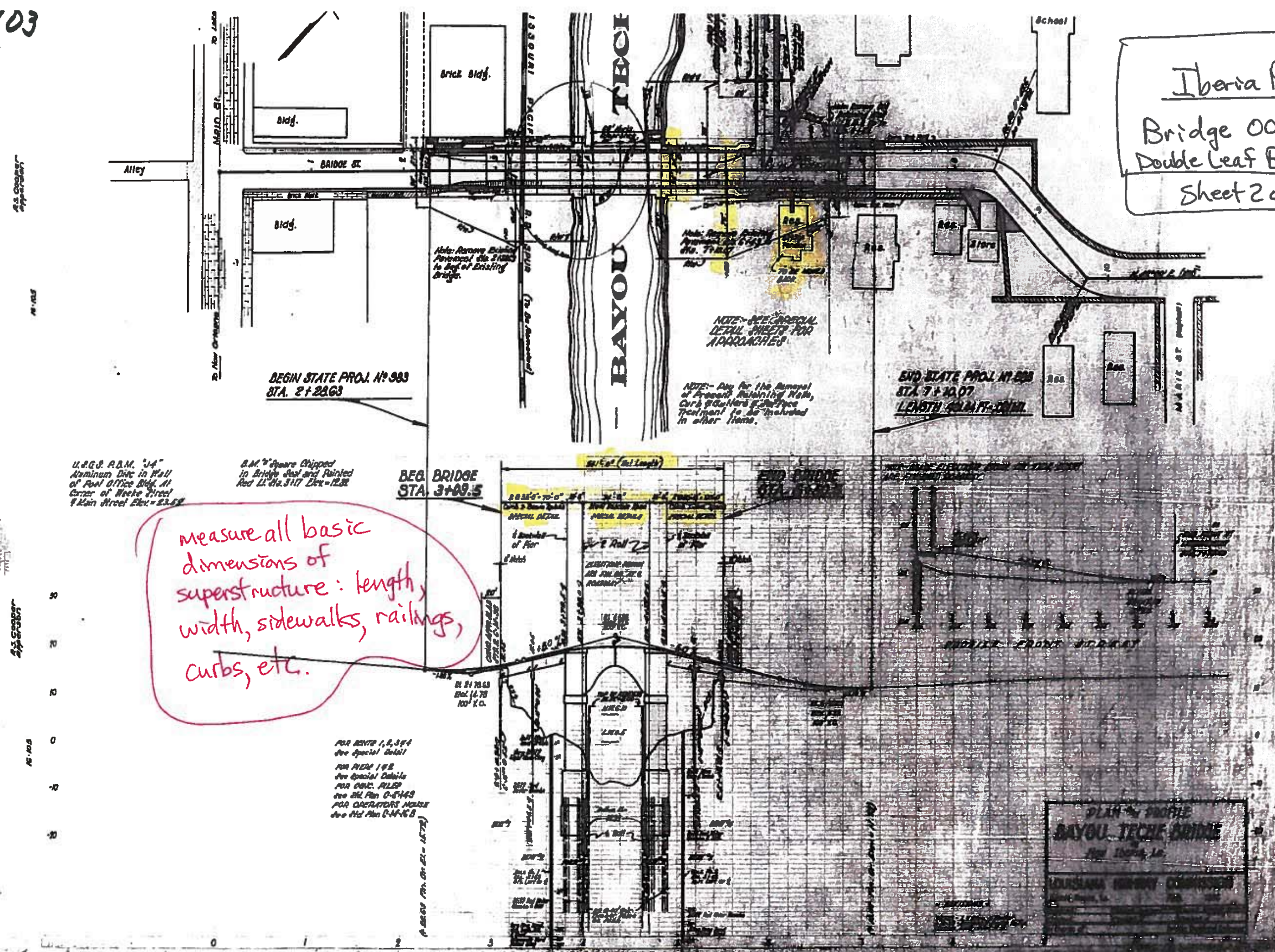

U.S.G.P. P.D.M. "JA"
Aluminum Disc in Wall
of Post Office Bldg. at
Corner of Weeks Street
& Main Street Elev. = 23.57

3.61" Square Chipped
in Bridge Deck and Painted
Red Lt. No. 3117 Dec. = 12.82

BEG. BRIDGE
STA. 3+09.5

END STATE PROJ. NO. 898
STA. 7+40.07
LENGTH 401.47'-00.00'

measure all basic
dimensions of
superstructure: length,
width, sidewalks, railings,
curbs, etc.

FOR RENT 1, 2, 3, 4
See Special Detail
FOR PILE 1 & 2
See Special Details
FOR CHAIN PILES
See Std. Plan O-5-143
FOR OPERATORS HOUSE
See Std. Plan O-5-143

PLAN & PROFILE
BAYOU TECHE BRIDGE
Iberia Parish, La.
JANUARY 1904



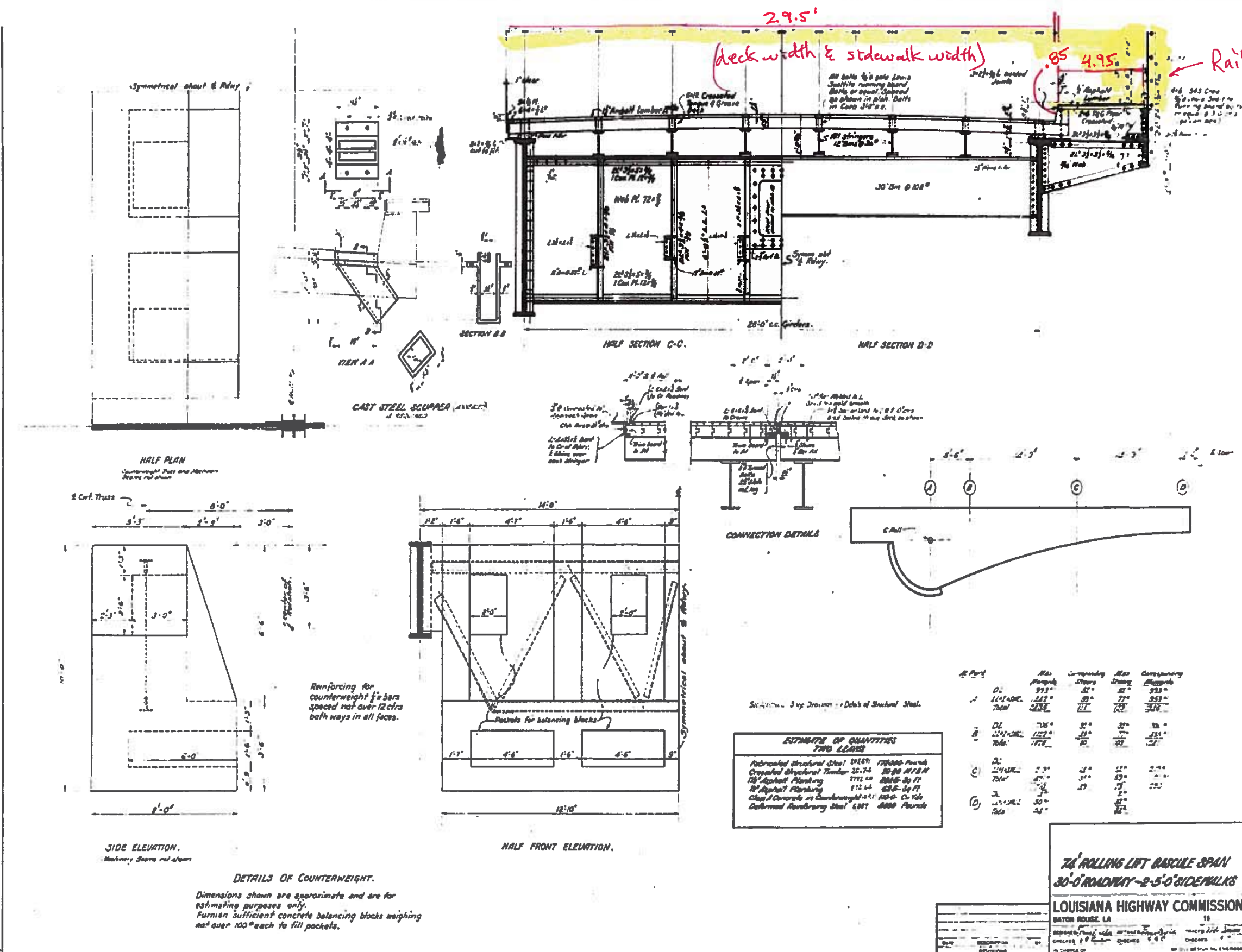

DETAILS OF COUNTERWEIGHT.
Dimensions shown are approximate and are for estimating purposes only. Furnish sufficient concrete balancing blocks weighing not over 100# each to fill pockets.



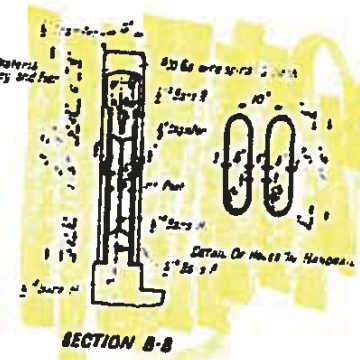
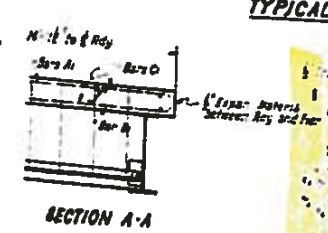
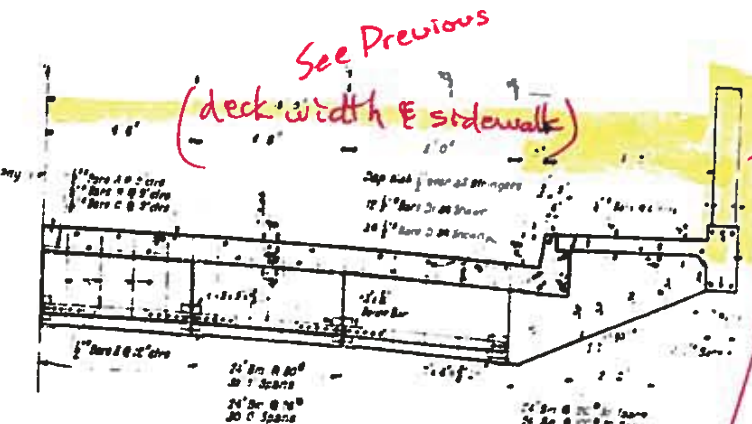
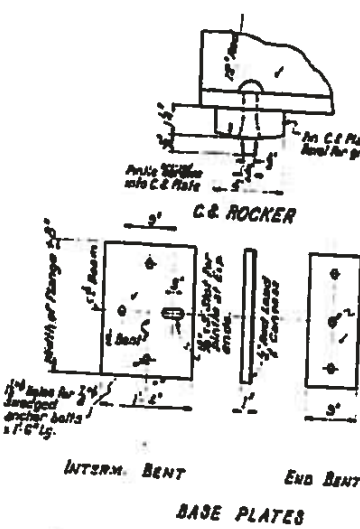
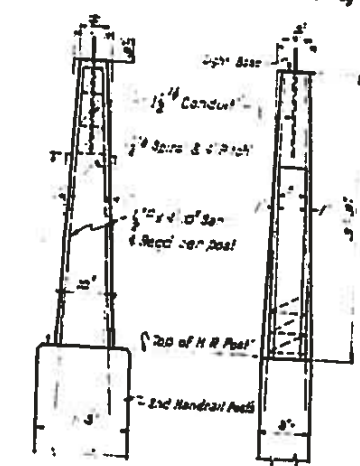
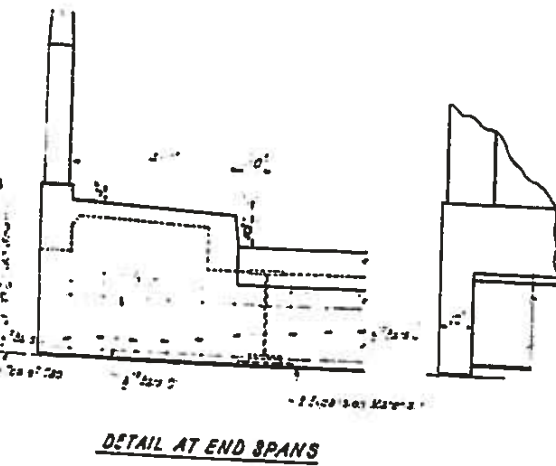
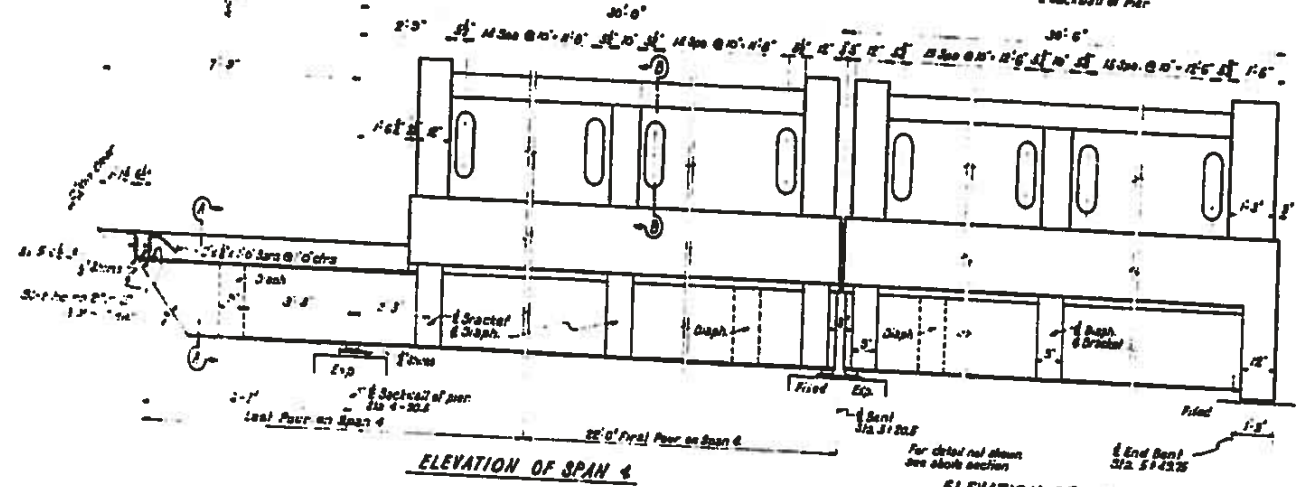
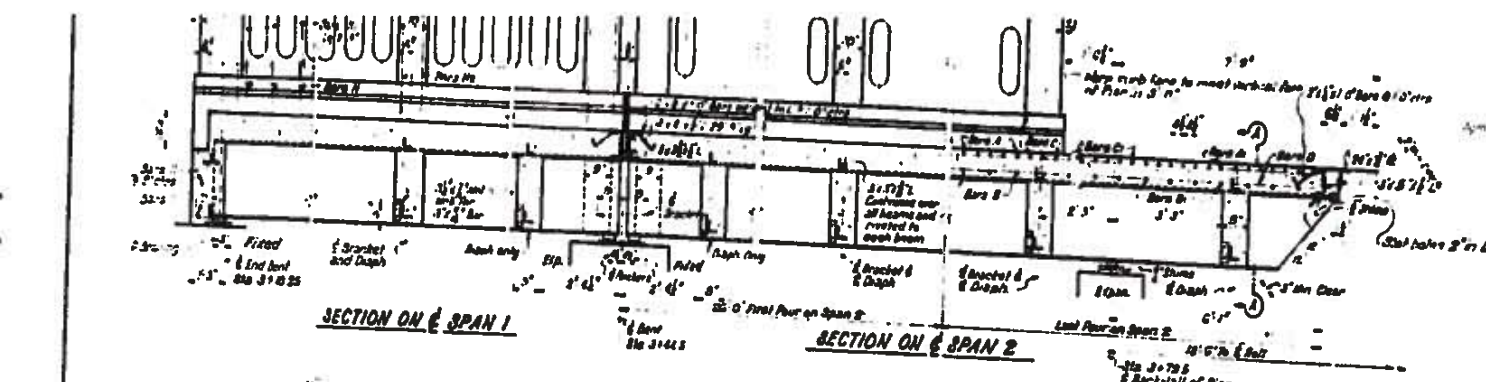

ESTIMATED QUANTITIES

Approach Spans	2 1/2 Tones	Mount Steel	Structural Steel
30 End Span A's	42.70	8708	25070
33 Interm. Span A's	66.25	5608	34.20
30 Interm. Span A's	41.17	8344	28360
30 End Span A's	37.36	7482	19190

General Notes
 1. Highway Comm. Special Contract to govern
 2. All exposed concrete to have Rubbed Finish
 3. All corners to have 1/4" chamfer unless noted
 4. All rivets to be 1/2"
 5. Cost of concrete in lamp posts to be included in price bid for other items
 6. Reinforcing steel dimensions are to bar centers
 7. Camber for D.L. on piers and for vertical curve to be rolled in structure at all the case of this work to be included in price bid for structural steel
 8. Cost of expansion material to be included in price bid for other items

APPROACH SPANS
 BAYOU TACHE BRIDGE
 AT
 NEW IBERIA, LA.
 LOUISIANA HIGHWAY COMMISSION
 BATON ROUGE, LA. JULY 17 1959

DESIGNED BY	CHAS. H. HAY	CHECKED BY	CHAS. H. HAY
DATE	REVISIONS	APPROVED BY	APPROVED BY



See Previous
 (deck width & sidewalk)
 railing height & type

005800
 Sheet 4 of 6

74

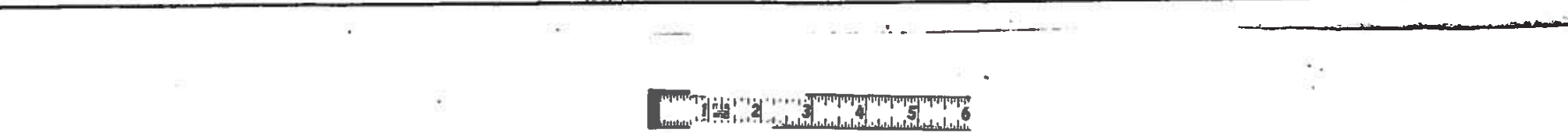
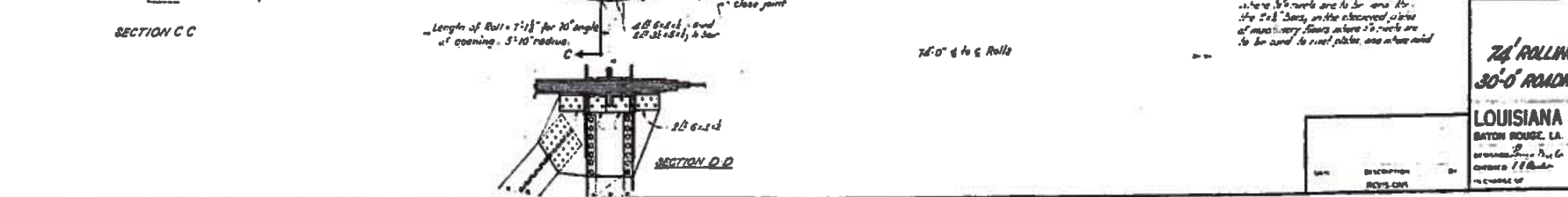
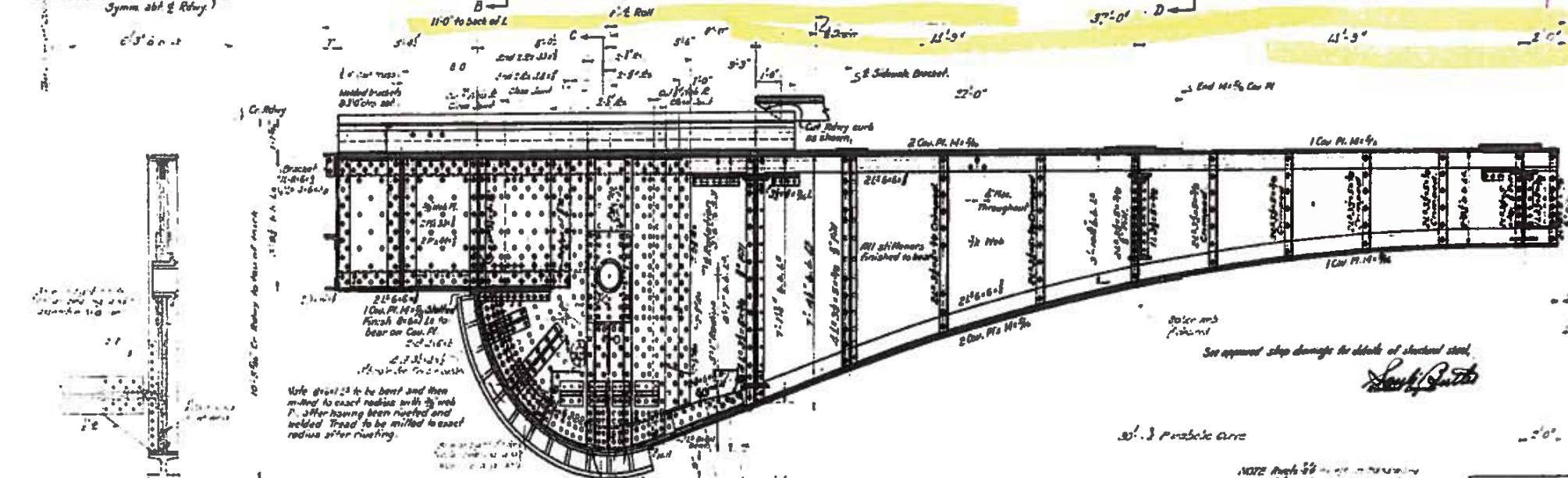
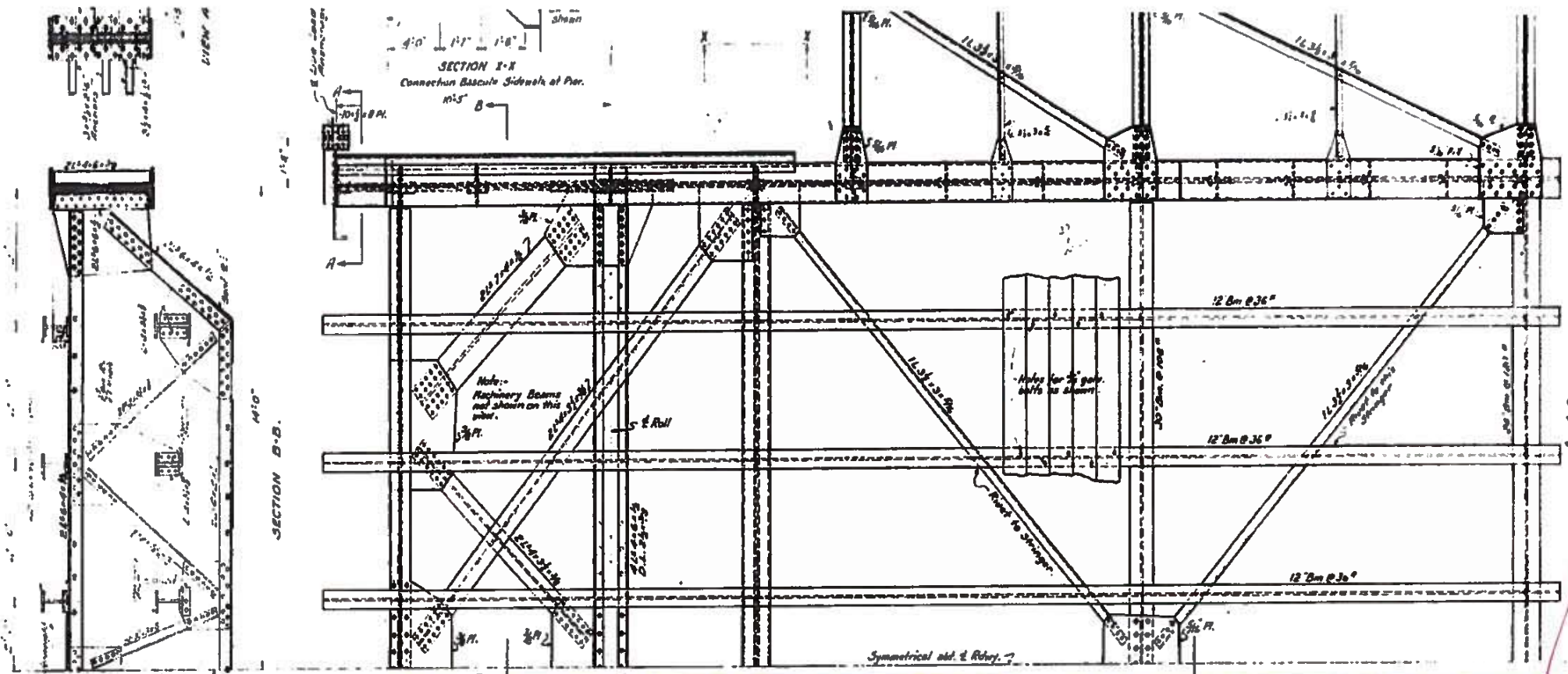

005800
Sheet 6 of 11

measure as much as
you can safely
record.

No Measurement
Separated by
Water Pit

74' ROLLING LIFT BASCULE SPAN
30'-0" ROADWAY - 2'-5" SIDEWALKS
LOUISIANA HIGHWAY COMMISSION
 BATON ROUGE, LA.
 DRAWN BY: [Signature] CHECKED BY: [Signature]
 DATE: [Date] SCALE: 1/4" = 1'-0"



005800
Sheet 7 of 11

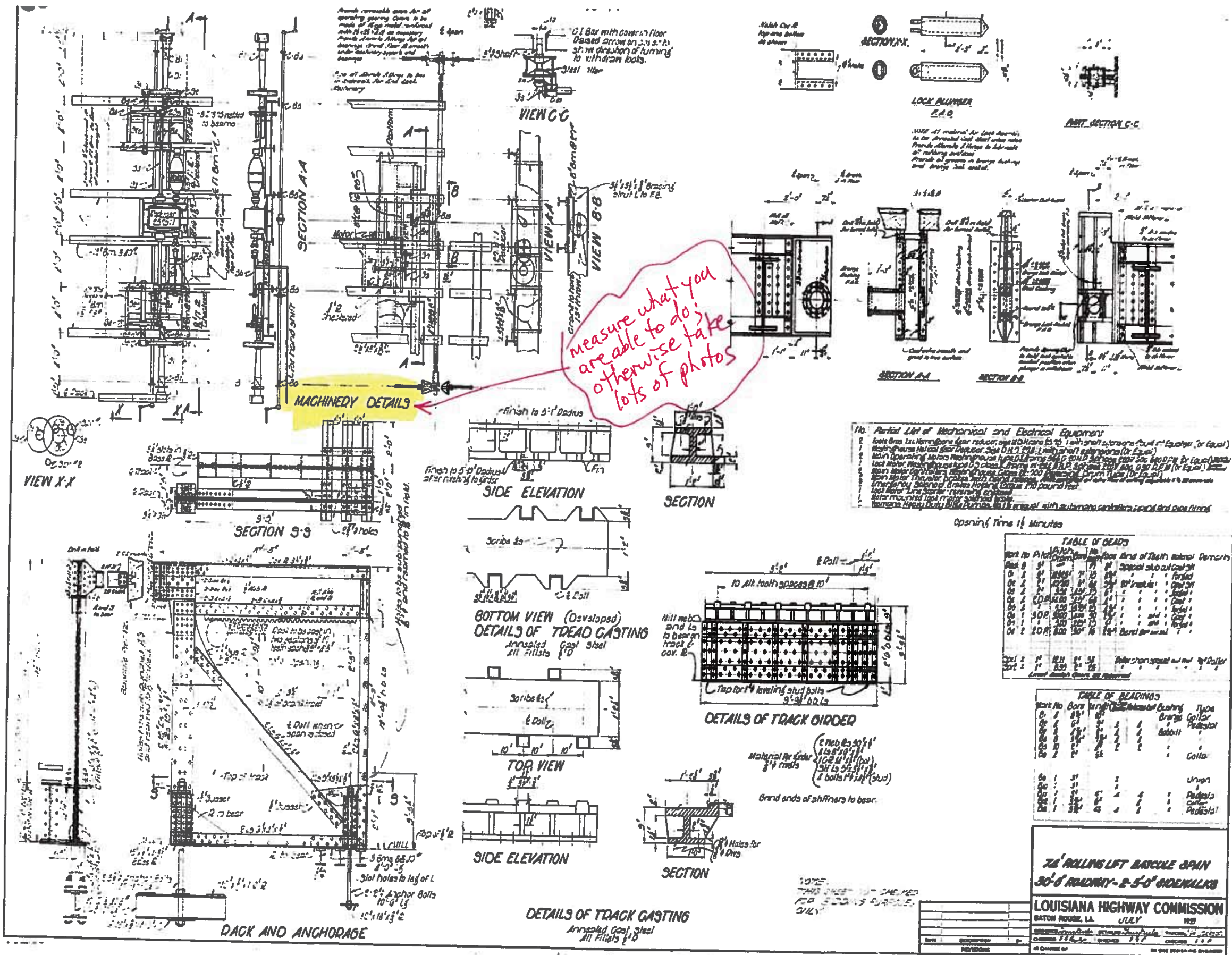

measure what you are able to do; otherwise take lots of photos

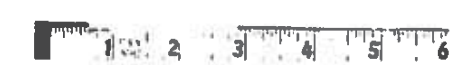

77

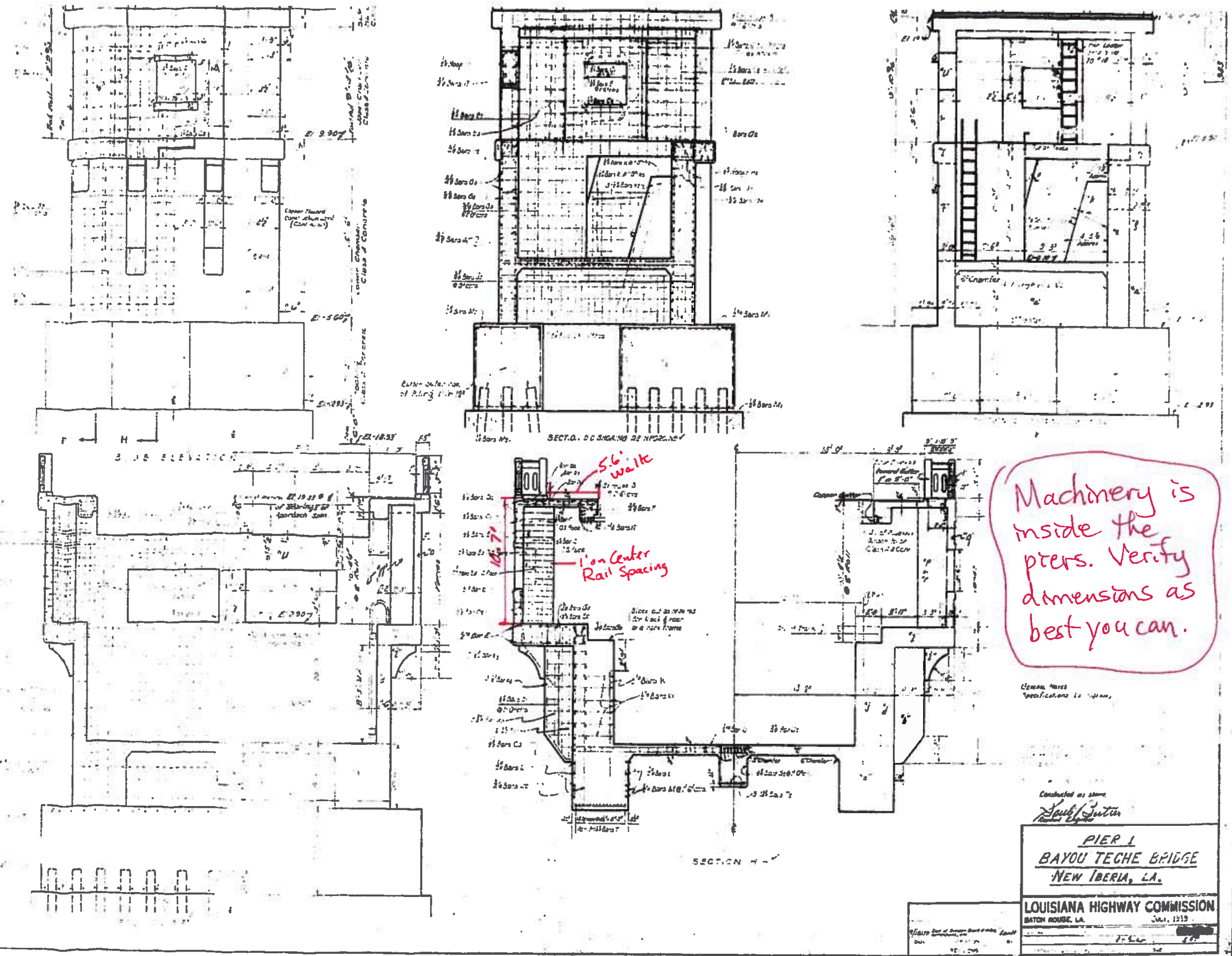

005800
Sheet 8 of 11

Machinery is
inside the
piers. Verify
dimensions as
best you can.

Constructed as shown
Saul J. Suter
PIER 1
BAYOU TECHE BRIDGE
NEW IBERIA, LA.
LOUISIANA HIGHWAY COMMISSION
 BATON ROUGE, LA. JULY, 1959



86

[Faint, illegible handwritten notes]

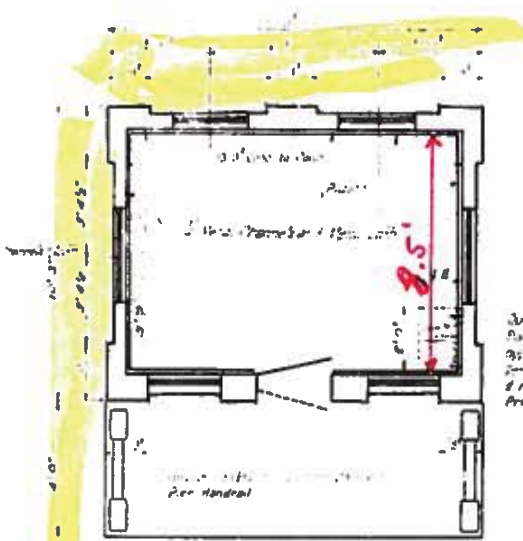

FLOOR SPACING PLAN

[Faint notes: Section B-B, Provide Job Rail above floor.]

UPPER FLOOR PLAN
SECTION B-B

These plans are not very good or readable. Do the best you can to verify dimensions.

005800
Sheet 9 of 11

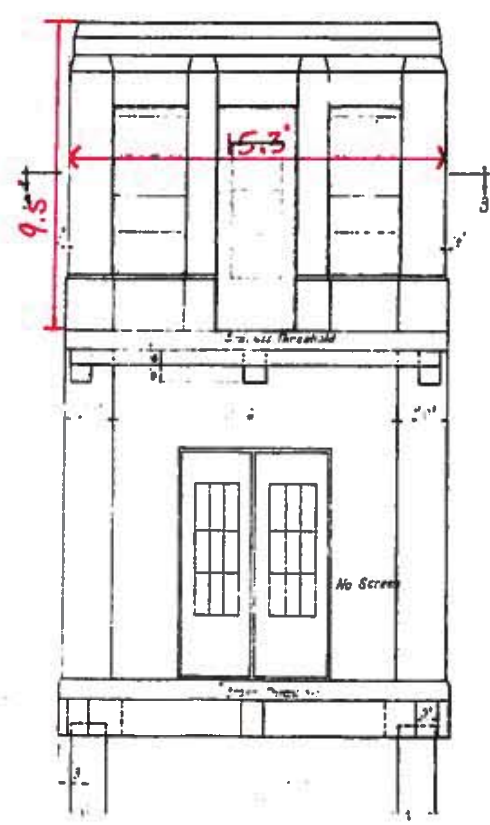
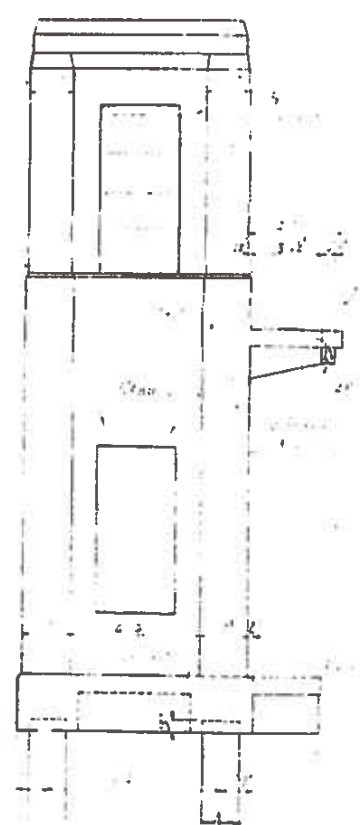

FRONT ELEVATION

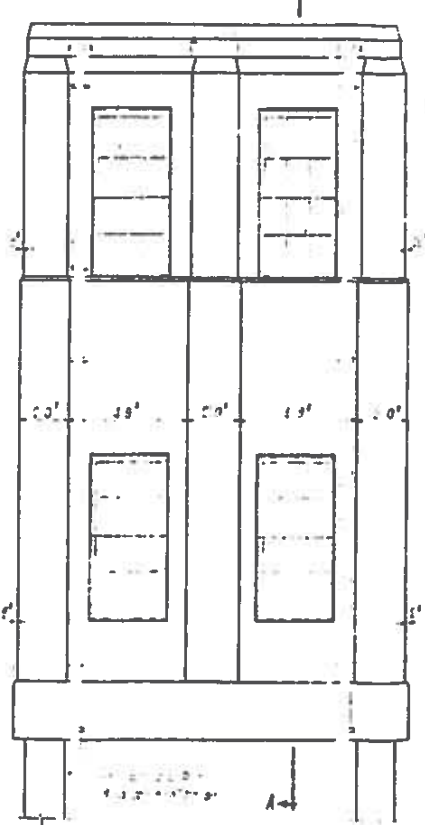

REAR ELEVATION

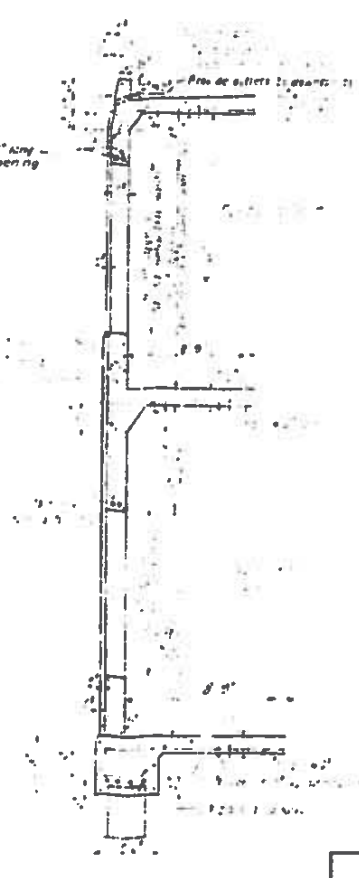

SECTION B-B

*Constructed as shown.
Louis J. Lutz
Resident Engineer*

STANDARD PLAN
OPERATOR HOUSE
OPERATORS & MACHINERY HOUSE

LOUISIANA HIGHWAY COMMISSION
BATON ROUGE, LA. 70801

[Small text: PREPARED BY... CHECKED BY... APPROVED BY...]

C-M-16B

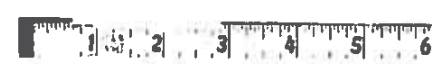

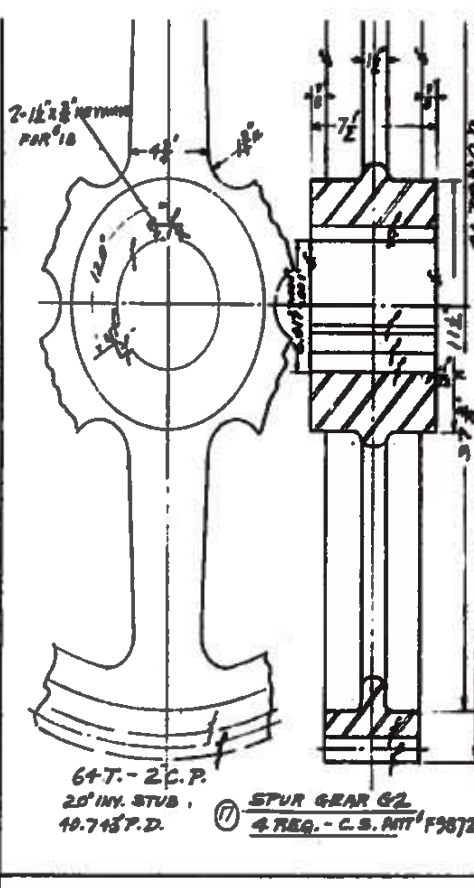
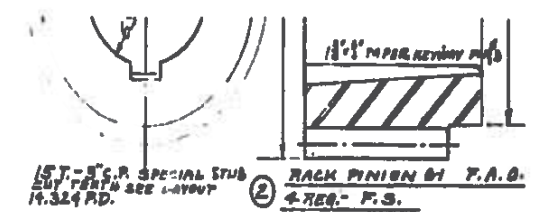
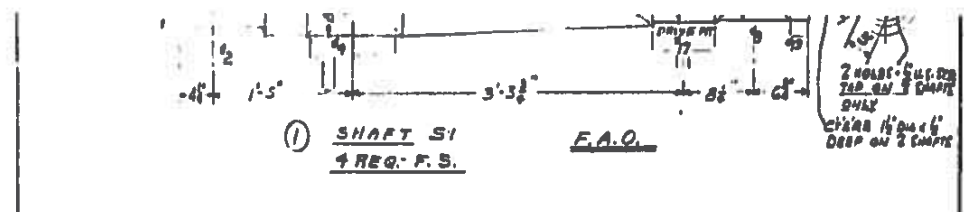

10. BOLT FOR S1	8	1/2"	1/2"	1/2"
11. CAP FOR S1	C.S.	2 1/2"	1 1/2"	1 1/2"
12. BOLT FOR S1	8	1/2"	1/2"	1/2"
13. BOLT FOR S1	8	1/2"	1/2"	1/2"
14. BOLT FOR S1	8	1/2"	1/2"	1/2"
15. BOLT FOR S1	8	1/2"	1/2"	1/2"
16. BOLT FOR S1	8	1/2"	1/2"	1/2"
17. BOLT FOR S1	8	1/2"	1/2"	1/2"
18. BOLT FOR S1	8	1/2"	1/2"	1/2"
19. BOLT FOR S1	8	1/2"	1/2"	1/2"
20. BOLT FOR S1	8	1/2"	1/2"	1/2"
21. BOLT FOR S1	8	1/2"	1/2"	1/2"
22. BOLT FOR S1	8	1/2"	1/2"	1/2"
23. BOLT FOR S1	8	1/2"	1/2"	1/2"
24. BOLT FOR S1	8	1/2"	1/2"	1/2"
25. BOLT FOR S1	8	1/2"	1/2"	1/2"
26. BOLT FOR S1	8	1/2"	1/2"	1/2"
27. BOLT FOR S1	8	1/2"	1/2"	1/2"
28. BOLT FOR S1	8	1/2"	1/2"	1/2"
29. BOLT FOR S1	8	1/2"	1/2"	1/2"
30. BOLT FOR S1	8	1/2"	1/2"	1/2"

005800
Sheet 10 of 11

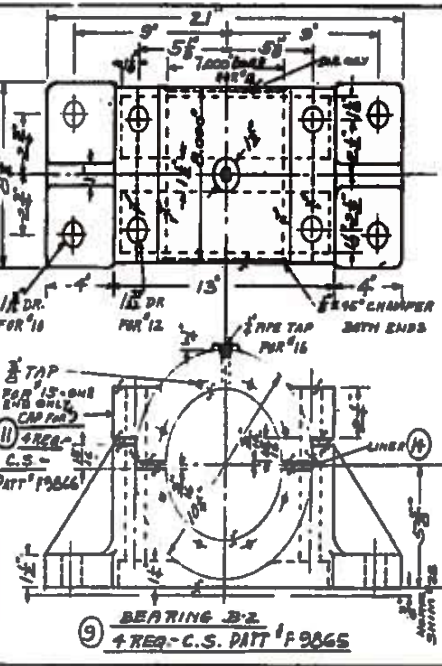
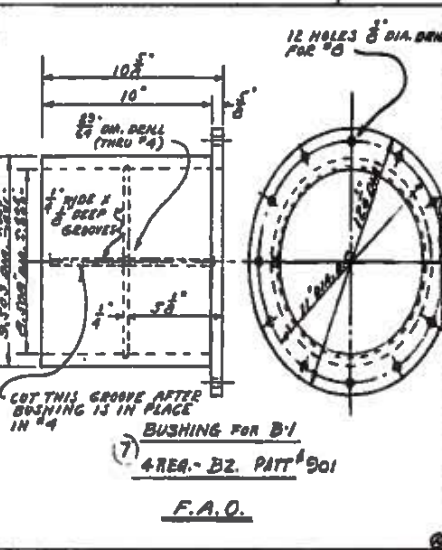
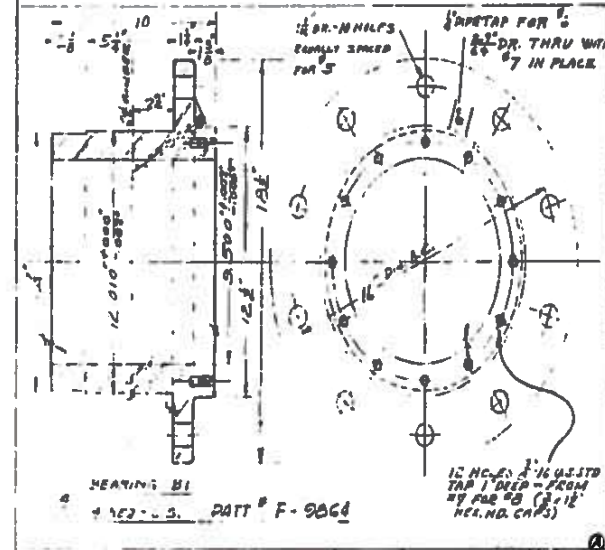

For information only

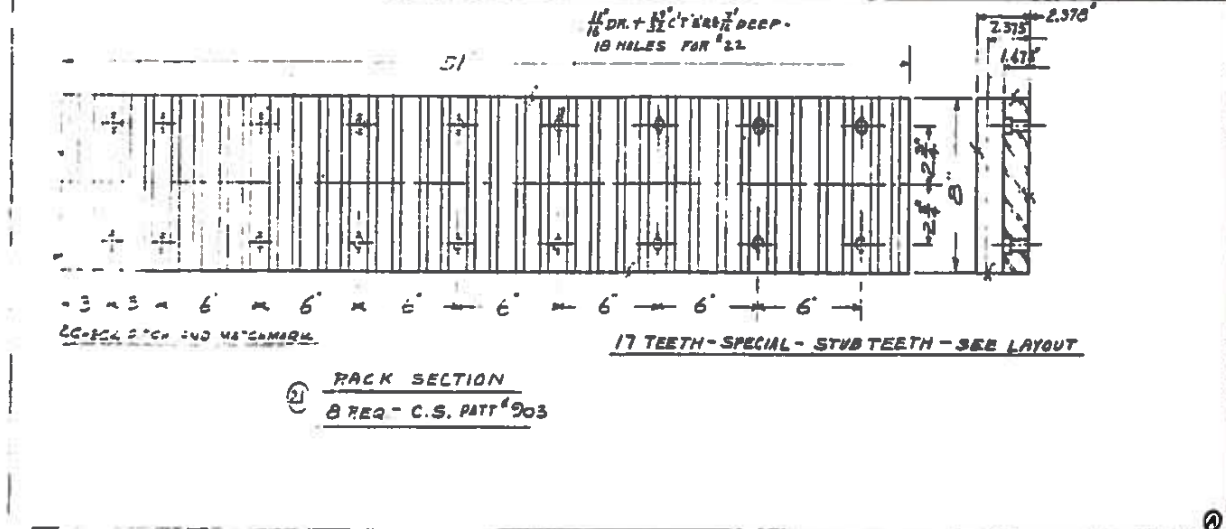
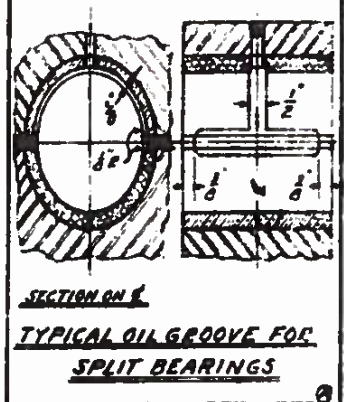
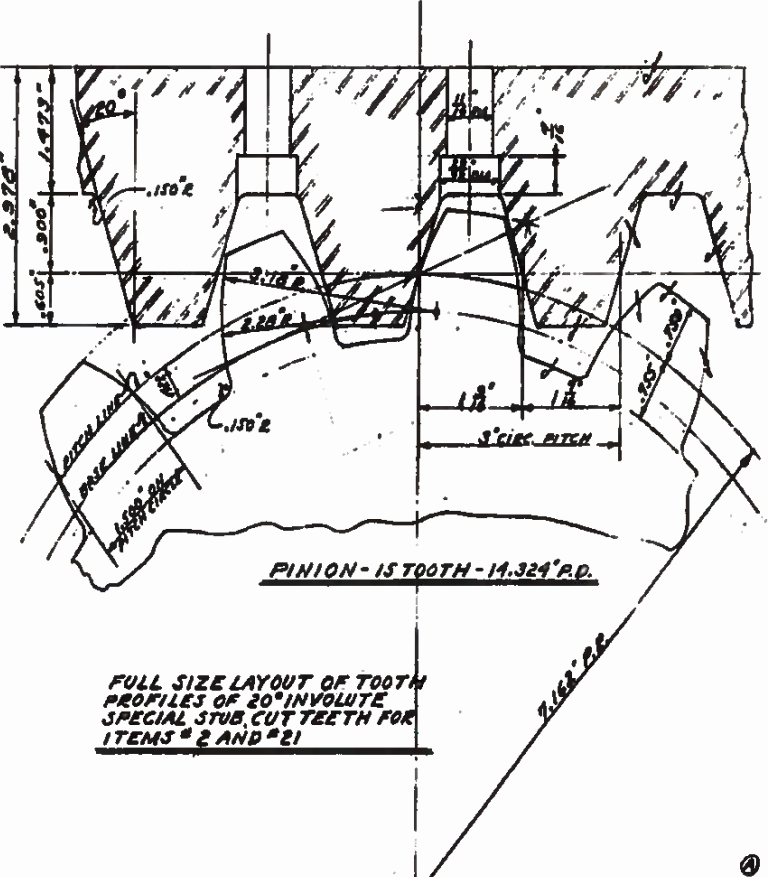
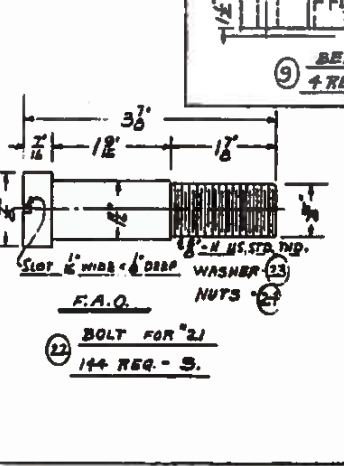
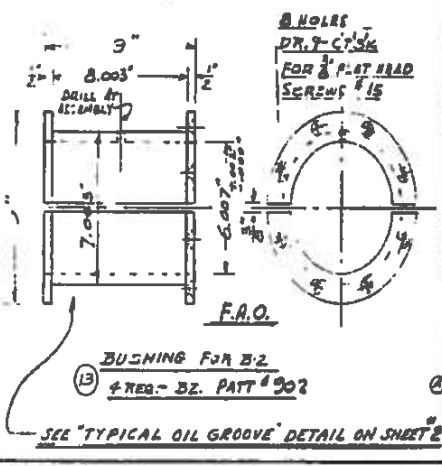
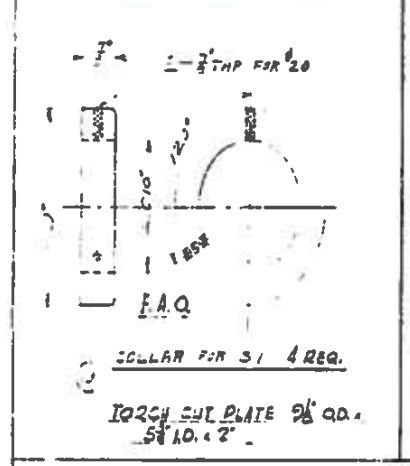

THE JAMES SAUNDERS COMPANY
DAYTON, OHIO
MANUFACTURERS - CONTRACTORS

NAME: LAYOU TRUSS BRIDGE
LOCATION: NEW IBERIA (IBERIA PARISH) LA.
FOR THE VINCENTS STEEL CORP.
FROM LOUISIANA STATE ROAD

20836 SHEET 2 OF 9

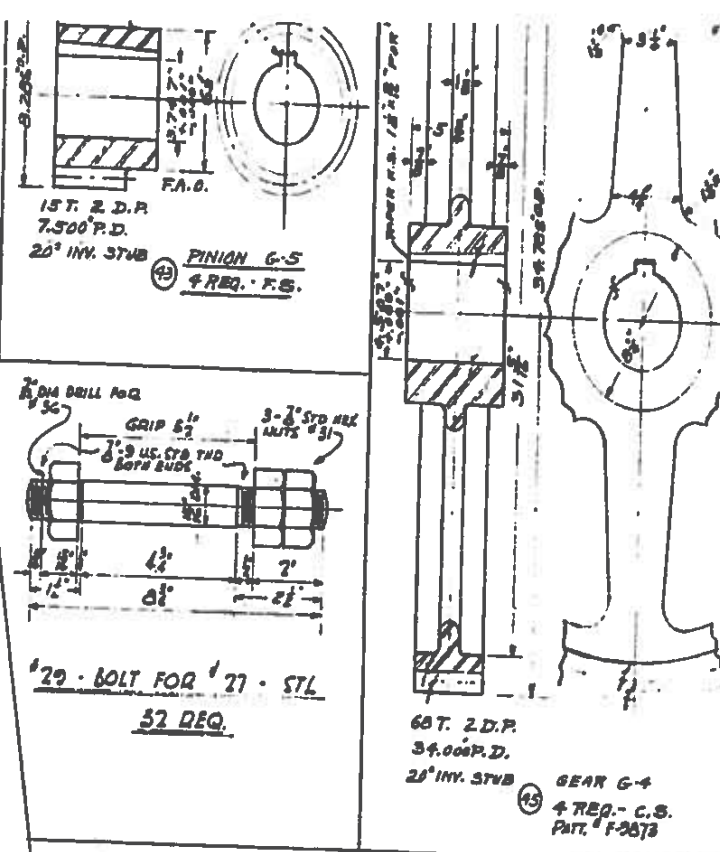
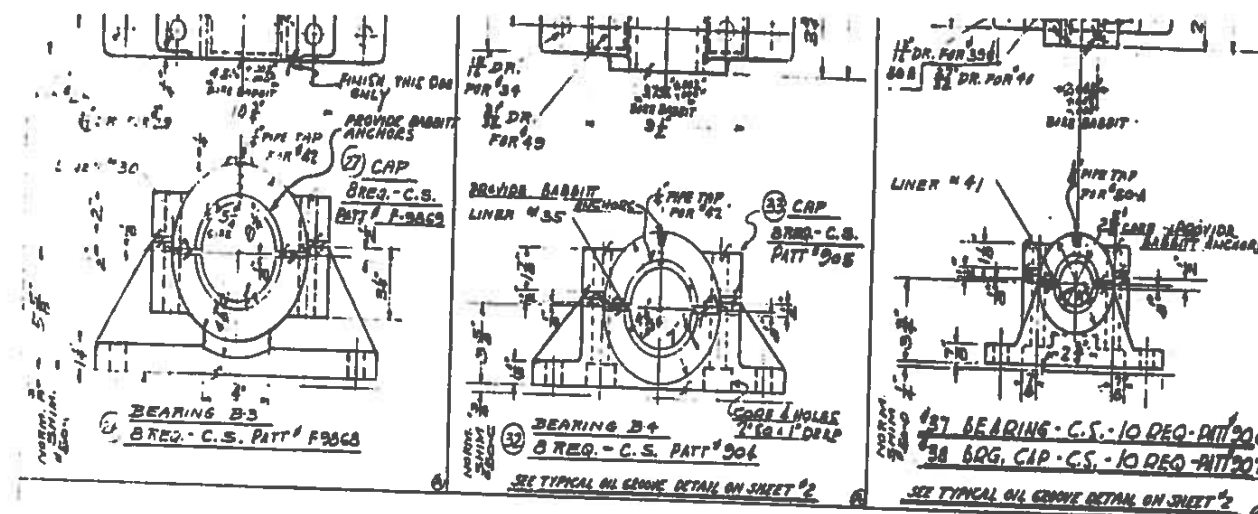

30 LINER FOR L. PORE	31 LINER FOR R. PORE
32 BEARING B 4	33 CAP FOR B 3
34 BOLT FOR B 3	35 LINER FOR B 3
36 CUTTERS FOR B 3	37 BEARING B 5
38 CAP FOR B 5	39 BOLT FOR B 5
40 LINER FOR B 5	41 BOLT FOR B 5
42 GILLES FOR B 5	43 PINION G 5
44 KEY FOR G 5	45 GEAR G 4
46 KEY FOR G 4	47 TRACK SEGMENT
48 BOLT FOR TRACK	49 BOLT FOR TRACK
50 GILLES FOR TRACK	51 GILLES FOR TRACK
52 GILLES FOR TRACK	53 GILLES FOR TRACK
54 GILLES FOR TRACK	55 GILLES FOR TRACK
56 GILLES FOR TRACK	57 GILLES FOR TRACK
58 GILLES FOR TRACK	59 GILLES FOR TRACK
60 GILLES FOR TRACK	61 GILLES FOR TRACK
62 GILLES FOR TRACK	63 GILLES FOR TRACK
64 GILLES FOR TRACK	65 GILLES FOR TRACK
66 GILLES FOR TRACK	67 GILLES FOR TRACK
68 GILLES FOR TRACK	69 GILLES FOR TRACK
70 GILLES FOR TRACK	71 GILLES FOR TRACK
72 GILLES FOR TRACK	73 GILLES FOR TRACK
74 GILLES FOR TRACK	75 GILLES FOR TRACK
76 GILLES FOR TRACK	77 GILLES FOR TRACK
78 GILLES FOR TRACK	79 GILLES FOR TRACK
80 GILLES FOR TRACK	81 GILLES FOR TRACK
82 GILLES FOR TRACK	83 GILLES FOR TRACK
84 GILLES FOR TRACK	85 GILLES FOR TRACK
86 GILLES FOR TRACK	87 GILLES FOR TRACK
88 GILLES FOR TRACK	89 GILLES FOR TRACK
90 GILLES FOR TRACK	91 GILLES FOR TRACK
92 GILLES FOR TRACK	93 GILLES FOR TRACK
94 GILLES FOR TRACK	95 GILLES FOR TRACK
96 GILLES FOR TRACK	97 GILLES FOR TRACK
98 GILLES FOR TRACK	99 GILLES FOR TRACK
100 GILLES FOR TRACK	101 GILLES FOR TRACK

005800
Sheet 11 of 11

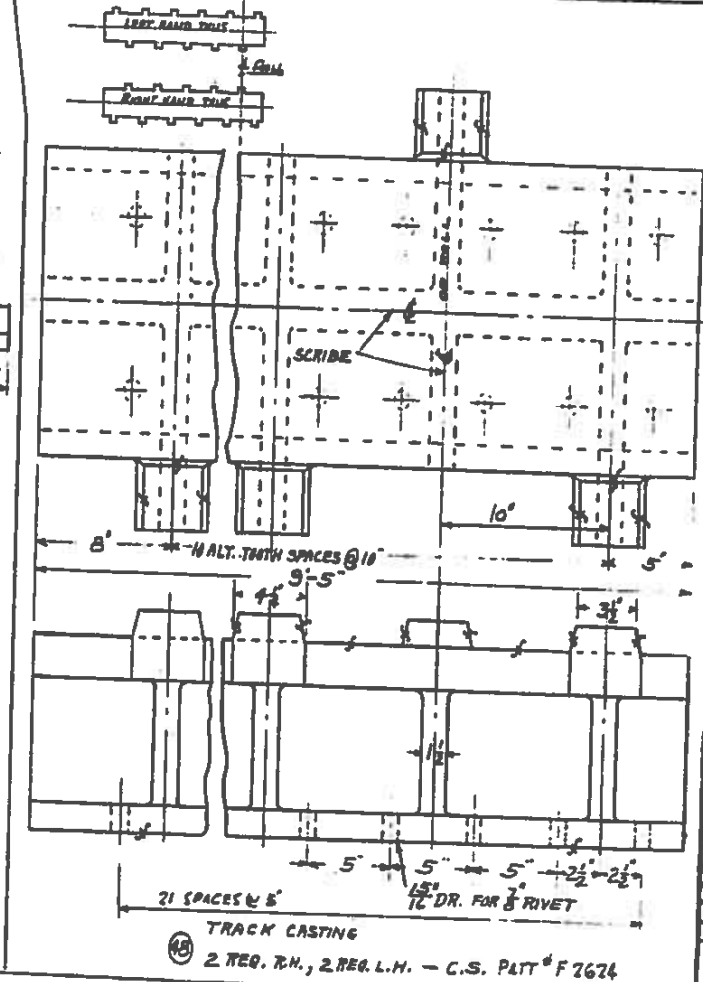
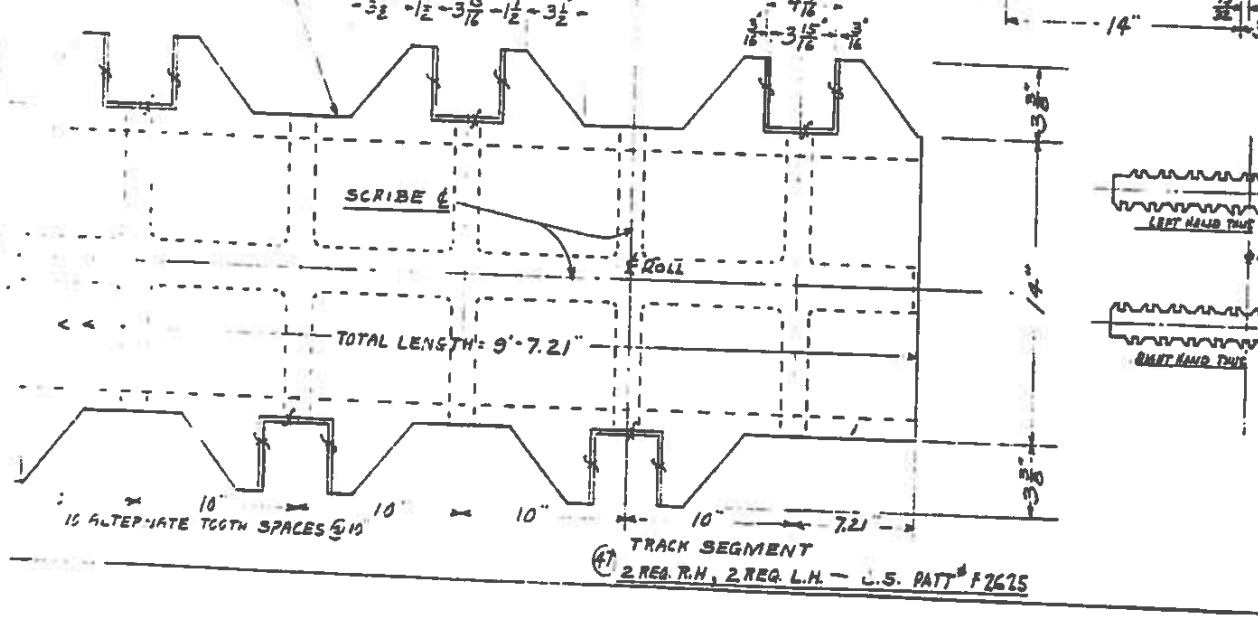
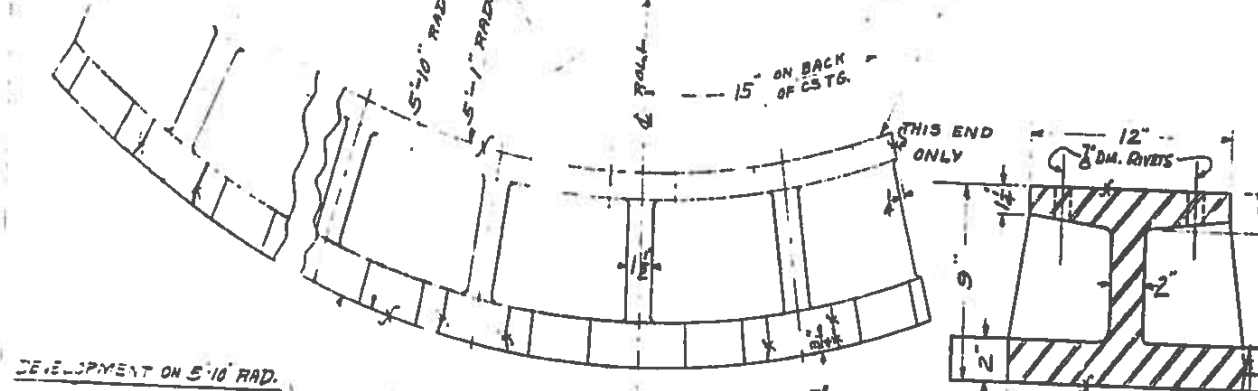
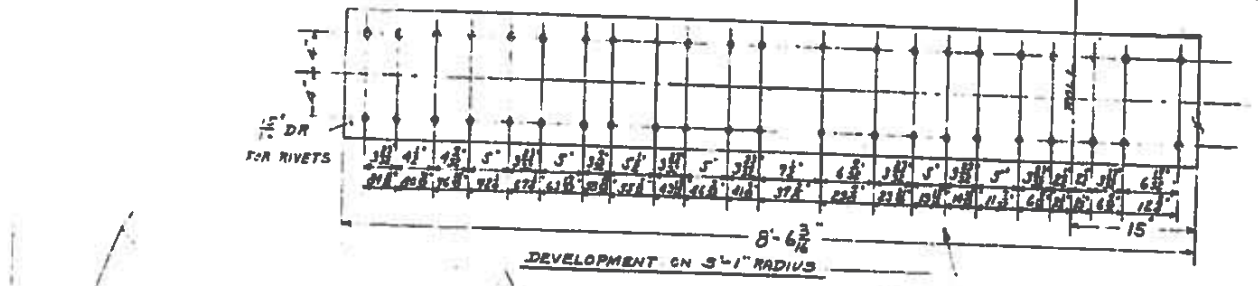

For Information
Only

THE JAMES SAUNDERS COMPANY	
DAYTON, OHIO	
MANUFACTURERS - CONTRACTORS	
FROM BAYOU TACHE BRIDGE	
LOCATED NEW ORLEANS (BRIDGE NO. 1)	
FOR THE WINN-DIXIE STEEL CORP.	
NEW ORLEANS, LOUISIANA STATE # 20836	
DATE: 11/15/40	DESIGNED BY: L.H. HUBBARD
CHECKED BY: [Signature]	DRAWN BY: [Signature]
20836	SHEET # 3 of 9